



HART Communication Application Guide



HCF_LIT-039 Rev. 7.1

Date of Publication: September 27, 2013

Document Distribution / Maintenance Control / Document Approval

To obtain information concerning document distribution control, maintenance control, and document approval please contact the HART Communication Foundation (HCF) at the address shown below.

Copyright © 2013 (1997-2012) HART Communication Foundation

This document contains copyrighted material and may not be reproduced in any fashion without the written permission of the HART Communication Foundation.

Trademark Information

HART® and *WirelessHART*® are registered trademarks of the HART Communication Foundation, Austin, Texas, USA. Any use of the term HART hereafter in this document, or in any document referenced by this document, implies the registered trademark. All other trademarks used in this or referenced documents are trademarks of their respective companies. For more information contact the HCF Staff at the address below.



HART Communication Foundation
9390 Research Boulevard
Suite I-350
Austin, TX 78759, USA
Voice: (512) 794-0369
FAX: (512) 794-3904

www.hartcomm.org

Intellectual Property Rights

The HCF does not knowingly use or incorporate any information or data into the HART Protocol Standards which the HCF does not own or have lawful rights to use. Should the HCF receive any notification regarding the existence of any conflicting Private IPR, the HCF will review the disclosure and either (a) determine there is no conflict; (b) resolve the conflict with the IPR owner; or (c) modify the standard to remove the conflicting requirement. In no case does the HCF encourage implementers to infringe on any individual's or organization's IPR.

Acknowledgement of contributions by Dresser Masonelian, Emerson and Moore Industries International, Inc.

Table of Contents

PREFACE	8
THEORY OF OPERATION	9
Communication Modes	10
Request-Response Mode	10
Burst Mode	10
Frequency Shift Keying (FSK)	11
Phase Shift Keying (PSK)	11
HART Networks	12
Point-to-Point	12
Multi-drop	13
Split Ranging Control Valves	14
Control in Field Devices	16
HART Field Controller Implementation	17
HART Commands	18
Universal	18
Common Practice	18
Device Specific	18
WirelessHART	21
Co-Existence	21
Channel Hopping	22
Time Division Multiplexing	22
Power Modulation	22
Direct Sequence Spread Spectrum	22
Mesh Networking	23
Blacklisting and Channel Assessment	23
How It Works	23
Components	25
Getting Started	25

<i>Benefits of HART Communication</i>	29
<i>Improved Plant Operations</i>	30
Cost Savings in Commissioning	30
Cost Savings in Installation	30
Digital Communication	30
Improved Measurement Quality	32
Cost Savings in Maintenance	33
<i>Operational Flexibility</i>	34
<i>Instrumentation Investment Protection</i>	35
Compatibility of HART Revisions	35
GETTING THE MOST OUT OF HART SYSTEMS	36
<i>Wiring and Installation</i>	37
Cable Length	37
<i>Intrinsic Safety</i>	38
Intrinsic Safety Devices	38
Designing an IS System Using Shunt-Diode Barriers	38
Designing an IS System Using Isolators	39
Multi-drop IS Networks	40
IS Output Loops	40
IS Certification Considerations	40
IS Network Cable Length Calculations	40
Safety Integrity Level (SIL)	41
<i>HART Multi-drop Networks</i>	42
Multi-drop with HART Field Controllers	43
Application Considerations	44
Configuring Devices for Multi-drop Operation	44
<i>Control System Interfaces</i>	45
HART I/O Subsystems	45
HART I/O for Multi-drop Support	45
HART I/O for Burst Mode Support	45
Data Handling	46

Pass-through Feature _____	46
Gateways _____	46
SCADA/RTU Systems _____	46
Multiplexers _____	47
Multiplexers – Remote I/O as the Primary I/O System _____	47
Parallel Monitoring with a Multiplexer _____	48
HART Over PROFIBUS _____	50
Reading HART Data into Non-HART Systems _____	51
Commissioning HART Networks _____	54
Device Verification _____	54
Loop Integrity Check _____	54
As-Installed Record Keeping _____	54
Device Status and Diagnostics _____	55
Connecting a PC to a HART Device or Network _____	56
INDUSTRY APPLICATIONS _____	57
APPLICATION _____	59
HART Multi-drop Network for Tank Level and Inventory Management _____	59
APPLICATION _____	60
Multi-drop for Tank Farm Monitoring _____	60
APPLICATION _____	61
Underground Petroleum Storage Using HART for Accuracy _____	61
Lonza Chooses HART Technology for Quick Validation and Commissioning _____	62
Genentech Uses HART to Reduce Life cycle Device Management, Installation and Start-Up Costs _____	65
DuPont Uses HART Data to Satisfy Safety Interlock System Valve Test Requirements _____	70
Eastman Chemical Uses HART Pressure Transmitter to Achieve Cost-Effective Maintenance _____	76
Monsanto Uses HART to Optimize Asset Reliability and Improve Productivity _____	78
Sasol Solvents Uses HART to Improve Asset Management _____	84
ORBCOMM Uses HART Communication in Satellites _____	91
to Transfer Data _____	91
BP Canada Energy Uses HART Communication to Improve Process Control and Save Money _____	94

<i>INRA Uses HART Communication to Gaining High Resolution Process Values</i>	99
<i>Cebrace Uses HART Interface for Asset Management Integration</i>	102
<i>Gas Pipeline Company Uses HART to Modernize Operations and Save \$1.25 million Annually</i>	106
<i>HART-to-Ethernet Gateway: Two Diverse Applications, One Solution</i>	109
REFINERY – MEXICO	109
WHEAT MILL – GERMANY	111
<i>PDVSA Uses HART Technology to Streamline Preventive Maintenance Process</i>	112
<i>Shell Uses HART Communication to Improve Nigerian Plant Operations</i>	115
<i>Statoil Uses HART Communication to Deliver Natural Gas from Under the Sea</i>	118
<i>Clariant Uses HART Technology to Solve Major Production Problem</i>	125
<i>BP Cooper River Uses HART Diagnostics to Save on Maintenance and Increase Productivity</i>	129
<i>New York Power Utility Uses HART to Reduce Costs and Improve Reliability</i>	133
<i>Ohio State University Uses HART to Reduce Risk to Product</i>	135
<i>Appleton Paper Uses HART to Improve Asset Management and Saves \$40,000 on Wiring Alone</i>	140
<i>Fraser Papers Gains Predictive Maintenance Edge Using HART Valve Positioning</i>	143
<i>Swedish Pulp and Paper Plant Uses HART Technology to Improve Plant Availability</i>	146
<i>Brazilian Steel Plant Uses HART Communication to Reduce Data Retrieval Time</i>	148
<i>AECOM Canada Uses HART Communication to Keep Waterways Clean</i>	151
<i>Detroit Water Deploys HART to Improve Customer Satisfaction</i>	154
<i>Milwaukee Sewerage District Uses HART to Support Safer Sewer System</i>	164
<i>Persian Gulf Company Uses HART Communication to Improve Water Conversion Process</i>	166
<i>Sluvad Water Treatment Works Employs HART Protocol’s Multi-Drop Network Capability for Flexibility, Redundancy, Cost Savings</i>	169
<i>WirelessHART Applications</i>	172
<i>WirelessHART Network Helps Steel Mill Increase Production and Reduce Costs</i>	173
<i>Electric Utility Uses WirelessHART Communication to Improve Performance Efficiency</i>	174
<i>WirelessHART at BASF</i>	176
<i>Where to Get Information</i>	180
<i>APPENDIX A: HART Checklist</i>	181
<i>APPENDIX B: HART Field Control</i>	185

APPENDIX C: Technical Information	187
GLOSSARY	189

PREFACE

In today's competitive environment, all companies seek to reduce operation costs, deliver products rapidly and improve product quality. The HART® (Highway Addressable Remote Transducer) Communication Protocol directly contributes to these business goals by providing cost savings in:

- Commissioning and installation
- Plant operations and improved quality
- Maintenance

The HART Application Guide has been created by the HART Communication Foundation to provide users of HART products with the information necessary to obtain the full benefits of HART digital instrumentation. The HART Communication Protocol is an open standard owned by the HCF member companies (membership includes 290 companies worldwide as of 09/2013). Products that use the HART protocol to provide both analog 4-20A and digital signals provide flexibility not available with any other communication technology.

The following four sections of this guide provide an understanding of how the HART technology works, insight on how to apply various features of the technology, and specific examples of applications implemented by HART Protocol users around the world:

- Theory of Operation
- Benefits of HART Communication
- Getting the Most out of HART Systems
- Industry Applications

THEORY OF OPERATION

The following sections explain the basic principles behind the operation of HART instruments and networks:

- Communication Modes
- Frequency Shift Keying
- HART Networks
- HART Commands

COMMUNICATION MODES

The digital communication signal has a response time of approximately 2-3 data updates per second without interrupting the analog signal. A minimum loop impedance of 230 Ω is required for communication.

REQUEST-RESPONSE MODE

HART is typically a *request-response communication protocol*, which means that during normal operation (2-3 data updates per second) each field device communication is initiated by a host communication device. Two hosts can connect to each HART loop. The primary host is generally:

- a) a distributed control system (DCS),
- b) a programmable logic controller (PLC), or
- c) a personal computer (PC).

The secondary host can be a handheld terminal or another PC. Field devices include transmitters, actuators and controllers that respond to commands from the primary or secondary host.

BURST MODE

Some HART devices support the optional *burst communication mode*. Burst mode enables faster communication (3-4 data updates per second). In burst mode, the host instructs the field device to continuously broadcast a standard HART reply message (e.g., the value of the process variable). The host receives the message at the higher rate until it instructs the device to stop bursting.

**Use burst mode to enable more than one passive
HART device to listen to communications on the HART loop**

FREQUENCY SHIFT KEYING (FSK)

The HART Communication Protocol is based on the Bell 202 telephone communication standard and operates using the *frequency shift keying* (FSK) principle. The digital signal is made up of two frequencies: 1,200 Hz and 2,200 Hz representing bits 1 and 0, respectively. Sine waves of these two frequencies are superimposed on the direct current (dc) analog signal cables to provide simultaneous analog and digital communications (Fig 1). Because the average value of the FSK signal is always zero, the 4-20mA analog signal is not affected.

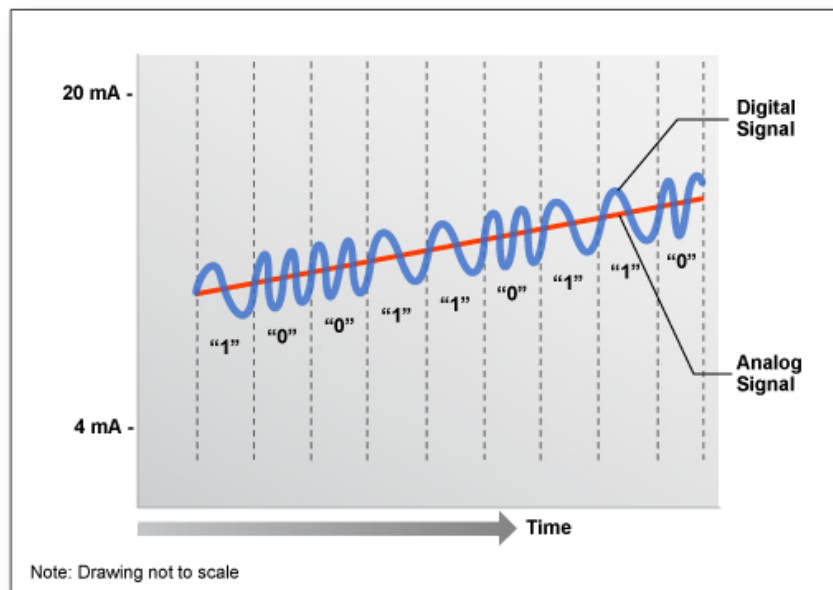

Digital over Analog

Figure 1 – Simultaneous analog and digital communications

PHASE SHIFT KEYING (PSK)

PSK Physical Layer—a higher speed physical layer option—is available in the HART 6 and HART 7 versions of the HART Protocol. PSK supports significantly faster communications with standard command/response throughput of up to 10-12 transactions per second simultaneous with the 4-20mA signal. This is an approved specification but (at the time of publication) no commercially produced chip is available to support implementation in 2-wire devices.

HART NETWORKS

HART devices can operate in one of two network configurations—Point-to-Point or Multi-drop.

POINT-TO-POINT

In point-to-point mode, the 4-20mA signal is used to communicate one process variable, while additional process variables, configuration parameters, and other device data are transferred digitally using the HART Protocol (Fig 2). The 4-20mA analog signal is not affected by the HART signal and can be used for control. The HART Communication digital signal gives access to secondary variables and other data that can be used for operations, commissioning, maintenance and diagnostic purposes.

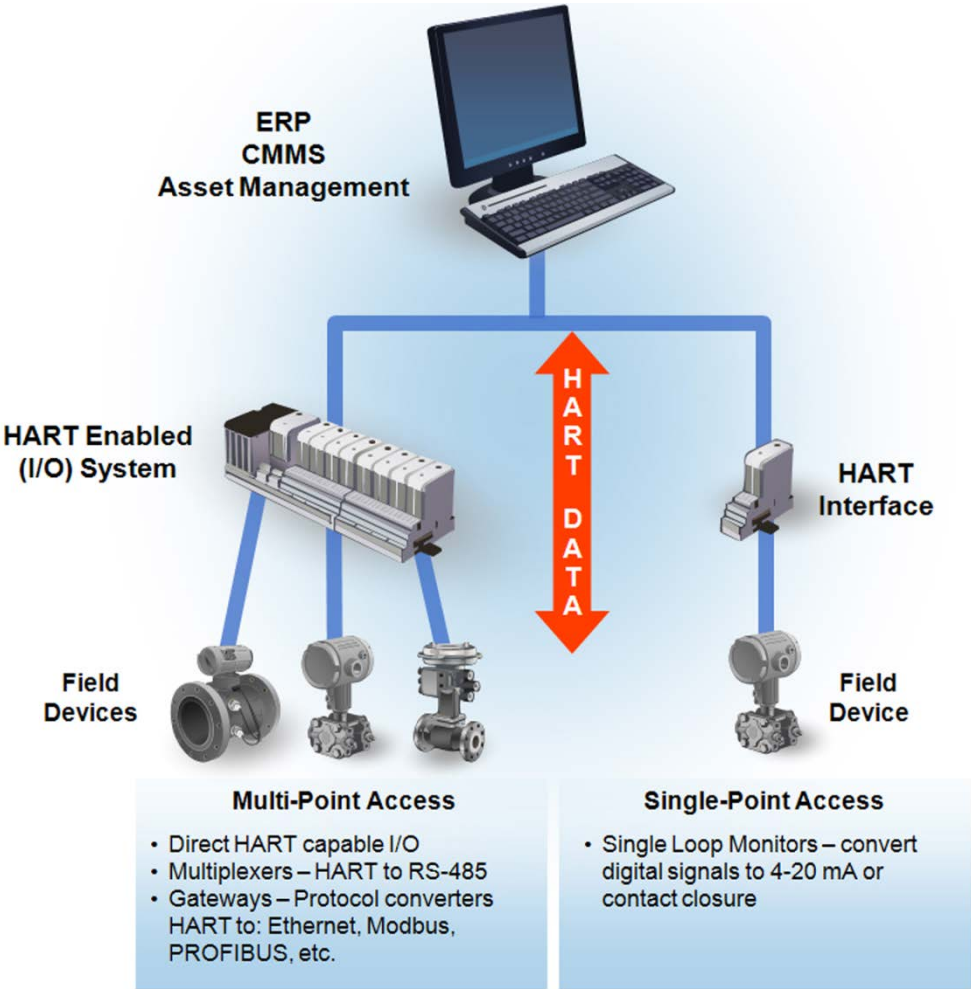

HART Data Integration

Figure 2 – Point-to-Point Communication

MULTI-DROP

The multi-drop mode of operation requires only a single pair of wires and, if applicable, safety barriers and an auxiliary power supply for up to 15 field devices (HART 5) or 62 field devices (HART 7) (Fig 3). All process values are transmitted digitally. In multi-drop mode, all field device polling addresses must be unique in a range of 1-63 (depending on the HART Protocol Revision) and the current through each device is fixed to a minimum value (typically 4mA).

Use multi-drop connection for supervisory control installations that are widely spaced such as pipelines, custody transfer stations, and tank farms.

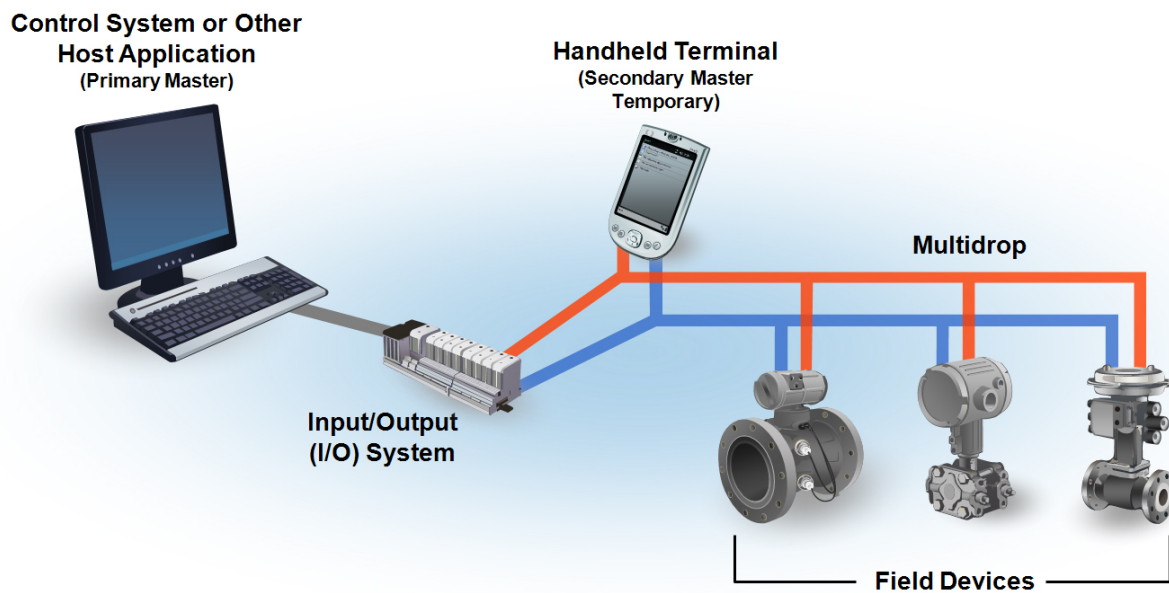

Note: Instrument power is provided by an interface or an external power source that is not shown.

Two Masters with Multidrop

Figure 3 – Multi-drop Communication

SPLIT RANGING CONTROL VALVES

Split range control is a single control loop divided into two or more independent final control elements such as valves acting in different directions or in different steps. There are many ways to implement a split range control: software, valve calibration or by connecting two or more positioners to a single control signal (usually 4-20mA).

HART-enabled intelligent valve positioners provide the easiest way to implement a split range control loop because of the easy-to-use configuration menus available in handheld terminals and the software configuration tools based on either DDs or DTMs.

With HART Communication the range for each intelligent valve positioner, as well as the control action, can be set with high precision; for example, air-to-open (ATO) or air-to-close (ATC) among others. Before proceeding with installation end users should check the following requirements for intelligent valve positioners:

- 5mA minimum current span
- 9 VDC minimum power
- At least 18 VDC (typical) available from power source (I/O card) for two valves

A typical split range loop with two valves will be configured as follows:

- Intelligent Valve Positioner #1
- Action: ATO (Air to Open)
- Input current range: 4-12mA

Intelligent Valve Positioner #2

Action: ATC (Air to Close)

Input Current range: 12-20mA

Position	4mA	12mA	20mA
Valve #1	Closed	Full Open	Full Open
Valve #2	Full Open	Full Open	Closed

Setting Loop Addresses for Split Range Systems

When more than one positioner is installed in a single current loop, the HART loop address of each device must be set to 1, 2, or 3 (or other non-zero values) to allow a HART master to recognize each intelligent valve positioner when connected to all three devices on a single current loop. Do not use “0” for any of the positioners. A “0” may cause HART masters to stop searching for additional positioners.

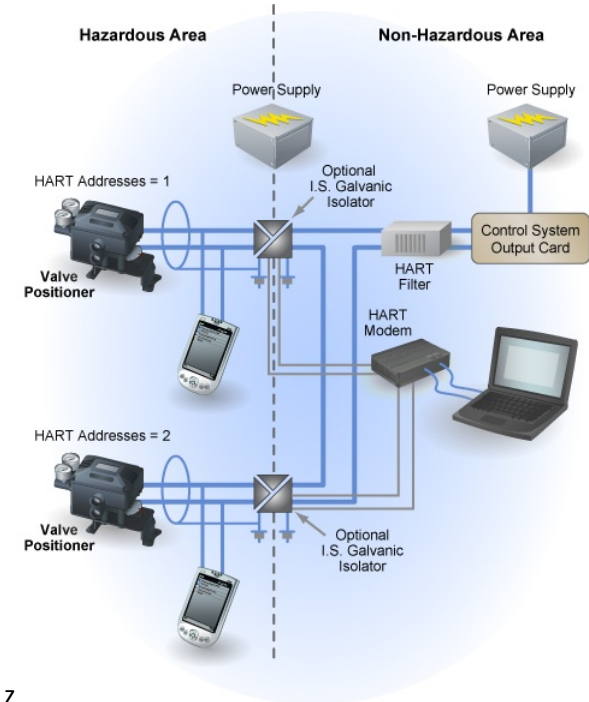

Figure 4 – Split Range with Isolators

Most HART-enabled intelligent valve positioners can perform other routines prior to commissioning such as:

- Find Stops
- Tuning
- Actuator action
- Shut-off function and limit

Today the use of HART intelligent valve positioners is considered as a “Best Practice” in the industry.

CONTROL IN FIELD DEVICES

Microprocessor-based smart instrumentation enables control algorithms to be calculated in the field devices, close to the process (Figure 5). Some HART transmitters and actuators support control functionality in the device, which eliminates the need for a separate controller and reduces hardware, installation, and start-up costs. Accurate closed-loop control becomes possible in areas where it was not economically feasible before. While the control algorithm uses the analog signal, HART communication provides the means to monitor the loop and change control set point and parameters.

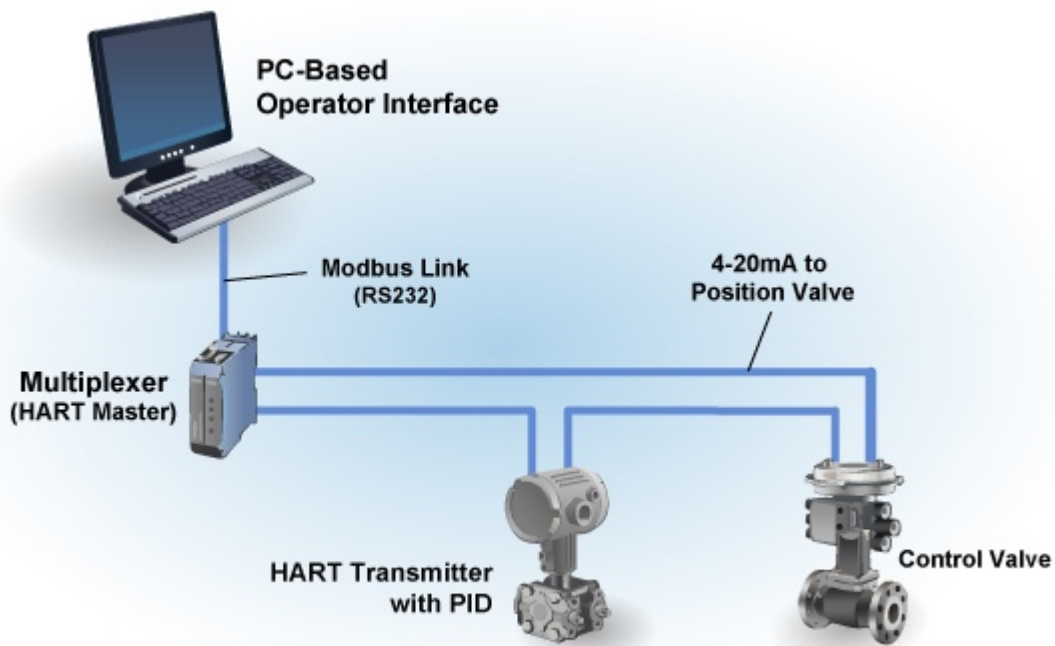

Figure 5 - Transmitter with PID

Placing control in the field enhances control functionality. Measurement accuracy is maintained because there is no need to transmit data to a separate controller. Control processing takes place at the high update rate of the sensor and provides enhanced dynamic performance.

HART FIELD CONTROLLER IMPLEMENTATION

A HART field controller takes advantage of the HART Protocol's simultaneous analog and digital signaling by converting the transmitter's traditional analog measurement output into a control output. The analog signal from the smart transmitter (controller) is used to manipulate the field device. The analog output signal also carries the HART digital signal, which is used for monitoring the process measurement, making set point changes, and tuning the controller.

The communication rate of the HART Protocol (2-3 updates per second) is generally perceived as too slow to support closed-loop control in the central host. With control in the field, the control function no longer depends on the HART Protocol's communication rate. Instead, the control signal is an analog output that is updated at a rate that is much faster than typically can be processed in a conventional control system.

Processing rates vary from 2-20 updates per second, depending on the product. The HART digital communication rate remains sufficient for monitoring the control variable and changing set point values.

HART COMMANDS

The *HART Command Set* provides uniform and consistent communication for all field devices. The command set includes three classes: *Universal*, *Common Practice*, and *Device Specific* (Table 1). Host applications may implement any of the necessary commands for a particular application.

UNIVERSAL

All devices using the HART Protocol must recognize and support the universal commands. Universal commands provide access to information useful in normal operations (e.g., read primary variable and units).

COMMON PRACTICE

Common Practice commands provide functions implemented by many, but not necessarily all, HART Communication devices.

DEVICE SPECIFIC

Device Specific commands represent functions that are unique to each field device. These commands access setup and calibration information, as well as information about the construction of the device. Information on Device Specific commands is available from device manufacturers.

Device Family Summary Table

Universal Commands	Common Practice Commands	Device Specific Commands
Read manufacturer and device type	Read selection of up to four dynamic variables	Read or write low-flow cut-off
Read primary variable (PV) and units	Write damping time constant	Start, stop, or clear totalizer
Read current output and percent of range	Write device range values	Read or write density calibration factor
Read up to four pre-defined dynamic variables	Calibrate (set zero, set span)	Choose PV (mass, flow, or density)
Read or write eight-character tag, 16-character descriptor, date	Set fixed output current	Read or write materials or construction information
Read or write 32-character message	Perform self-test	Trim sensor calibration
Read device range values, units, and damping time constant	Perform master reset	PID enable
Read or write final assembly number	Trim PV zero	Write PID set point
	Write PV unit	Valve characterization

Universal Commands	Common Practice Commands	Device Specific Commands
Write polling address	Trim DAC zero and gain Write transfer function (square root/linear) Write sensor serial number Read or write dynamic variable assignments	Valve set point Travel limits User units Local display information

Table 1 - HART Commands

This is a partial list of HART commands. See Appendices B, C, and D for more detailed information.

Establishing Communication with a HART Device

Each HART device has a unique 38-bit address that consists of the manufacturer ID code, device type code and device-unique identifier. A unique address is encoded in each device at the time of manufacture. A HART master must know the address of a field device in order to communicate successfully with it. A master can learn the address of a slave device by issuing one of two commands that cause the slave device to respond with its address:

Command 0, Read Unique Identifier—Command 0 is the preferred method for initiating communication with a slave device because it enables a master to learn the address of each slave device without user interaction. Each polling address (0–15) is probed to learn the unique address for each device.

Command 11, Read Unique Identifier by Tag - Command 11 is useful if there are more than 15 devices in the network or if the network devices were not configured with unique polling addresses. (Multi-dropping more than 15 devices is possible when the devices are individually powered and isolated.) Command 11 requires the user to specify the tag numbers to be polled.

Device Description

HART Communication was the first protocol to implement Electronic Device Description Language (EDDL) as its standard. EDDL (IEC 61804-2, EDDL) is the only technology endorsed by the HART Communication Foundation for configuration of HART devices. It is the most important and widely used digital communication descriptive language, providing a stable platform for suppliers to define and document the capabilities of HART-enabled products in a single, open and consistent format.

Device Descriptions (DDs), created by using Device Description Language, provide the information needed by a host application or control system to properly access and display important device information located in intelligent field devices. The DD includes all of the information needed by a host application to fully communicate with the field device.

HART EDDL is used to write a DD that combines all of the information needed by the host application into a single structured file. The DD identifies which Common Practice Commands are supported as well as the format and structure of all Device Specific Commands.

A DD for a HART field device is roughly equivalent to an electronic data sheet. DDs eliminate the need for host suppliers to develop and support custom interfaces and drivers. A DD provides a picture of all parameters and functions of a device in a standardized language. HART suppliers have the option of supplying a DD for their HART field product. If they choose to supply one, the DD will provide information for a DD-enabled host application to read and write data according to each device's procedures.

DD source files for HART devices resemble files written in the C programming language. DD files are submitted to the HCF for registration in the HCF DD Library. Quality checks are performed on each DD submitted to ensure specification compliance, to verify that there are no conflicts with DDs already registered, and to verify operation with standard HART hosts. The HCF DD Library is the central location for management and distribution of all HART DDs to facilitate use in host applications such as PCs and handheld terminals.

DDs can be downloaded at www.hartcomm.org.

WIRELESSHART

As the need for additional process measurements increases, users seek a simple, reliable, secure and cost-effective method to deliver new measurement values to control systems without the need to run more wires. With process improvements, plant expansions, regulatory requirements and safety levels demands for additional measurements, users are looking to wireless technology for that solution.

With approximately 40 million HART devices installed and in service worldwide (as of 09/2013), HART technology is the most widely used field communication protocol for intelligent process instrumentation. With the additional capability of wireless communication, the legacy of benefits this powerful technology provides continues to deliver the operational insight users need to remain competitive.

CO-EXISTENCE

Co-existence is defined as: *The ability of one system to perform a task in a given shared environment where other systems have an ability to perform their task and may or may not be using the same set of rules.* Successful co-existence is measured by the reliability of each network to deliver its messages to the desired destination. Therefore, each network must be able to accomplish its objective while not disrupting the ability of another network to complete its objective.

Problems can occur when two or more packets of information are transmitted at the same time and frequency so that they “collide” in the same physical space. If networks aren’t designed to minimize or avoid these occurrences, unreliable communications will result.

There are several techniques that can be used to minimize network interference:

- Channel hopping – changing the frequency channel
- Time Division Multiplexing – varying the time of communications
- Power Modulation – low power transmission
- Direct Sequence Spread Spectrum
- Mesh networking supports large physical space with low power instruments
- Blacklisting and channel assessment

In the data link layer of the *WirelessHART* specification, packet acknowledgment with automatic retry assures data is not lost if interference does happen to occur.

CHANNEL HOPPING

As specified by IEEE802.15.4, the 2.4 GHz ISM frequency band is divided into 16 non-overlapping frequency channels. *WirelessHART* instruments use a pseudo-random channel hopping sequence to reduce the chance of interference with other networks, such as IEEE802.11b/g (Wi-Fi) which operates in the same ISM frequency band.

There is a potential of overlap between IEEE802.11g and IEEE802.15.4 radios. Since the 802.11b/g channels are wider, there are only 3 non-overlapping channels for Wi-Fi networks. A given IEEE802.11 Wi-Fi access point will only use 1 of the 3 non-overlapping channels and will only broadcast periodically, so the channel is not in continuous use.

Pseudo-random channel hopping inherent to *WirelessHART* instruments ensures that they do not fix on using a channel being used by an IEEE802.11b/g network for any lengthy period of time. Together with the other techniques listed above, the probability of interference is minimal either way.

TIME DIVISION MULTIPLEXING

A *WirelessHART* network utilizes Time Division Multiple Access (TDMA) technology to ensure that only one instrument is talking on a channel at any given time. This prevents message collisions within the *WirelessHART* network. A network is provided with an overall schedule which is divided into 10 msec timeslots. At any time, only one pair of instruments are communicating on the same frequency channel, however, it is possible that more than one pair of instruments can communicate at the same time using different channels. In most cases, only one pair of instruments is communicating in a given timeslot so the *WirelessHART* network will not monopolize the frequency spectrum that is shared with other wireless networks.

POWER MODULATION

The IEEE802.15.4 radios were chosen because they are relatively low power instruments suited to wireless process control applications, as well as being readily available at a reasonable cost. The radios are used with 10dB amplifiers to allow communication of up to 200m to the next instrument, which in turn can serve as a router to pass the message along. In cases where the full distance is not required, *WirelessHART* instruments can transmit at a lower power to reduce the chance of interfering with other networks in the ISM frequency band. The lower transmit power of *WirelessHART* instruments also means that any chance of interfering with an IEEE802.11b/g Wi-Fi network is small.

DIRECT SEQUENCE SPREAD SPECTRUM

Direct Sequence Spread Spectrum (DSSS) technology provides about 8dB of additional gain utilizing unique coding algorithms. The transmission is spread over the entire frequency of the selected 802.15.4 channel. Devices with the correct decoding information can receive the data while others see the transmissions as white noise and disregard it. This allows multiple overlapping radio signals to be received and understood only by other devices in their own networks.

MESH NETWORKING

The use of mesh networking technology complements the use of the low power IEEE802.15.4 radios. With mesh networking, instruments do not need to have a direct transmission path to the network gateway. It is only required that any instrument be able to communicate to any other instrument in the mesh network. Each *WirelessHART* field instrument is capable of routing the message of other instruments along a route that will ensure the message is received at its ultimate gateway destination. Mesh networks also provide path redundancy and thus achieve better reliability than if each instrument were required to have a direct line of sight path to the gateway. The mesh network can adapt to changing communication and other environmental conditions to find a reliable communication path to the gateway.

Physical separation of >1m between *WirelessHART* instruments and Wi-Fi access points is all that is required for peaceful coexistence between the two types of wireless networks.

A direct or point-to-point connection to the gateway is also available for applications that might require faster update speeds.

BLACKLISTING AND CHANNEL ASSESSMENT

In conjunction with channel hopping the *WirelessHART* network can be configured to avoid specific channels that are highly utilized by other networks and therefore, are likely to provide interference. However, because most networks are not loaded continuously this is rarely required.

To further avoid any conflict with other neighboring networks a *WirelessHART* instrument listens to the frequency channel prior to transmitting data. If other transmissions are detected the *WirelessHART* instrument will back off and attempt the communication in another timeslot on a different frequency.

HOW IT WORKS

WirelessHART is a wireless mesh network communications technology for process automation applications. It adds wireless capabilities to the HART Protocol while maintaining compatibility with existing HART devices, commands, and tools.

Each *WirelessHART* network includes three main elements:

- **Wireless field devices** connected to process or plant equipment. These devices can be a device with *WirelessHART* built in or an existing installed HART-enabled device with a *WirelessHART* adapter attached to it.
- **Gateways** enabling communication between the field devices and host applications connected to a high-speed backbone or other existing plant communications network.
- **A Network Manager** responsible for configuring the network, scheduling communications between devices, managing message routes, and monitoring network health. The Network Manager can be integrated into the gateway, host application, or process automation controller.

The network uses IEEE 802.15.4 compatible radios operating in the 2.4GHz Industrial, Scientific, and Medical radio band. The radios employ direct-sequence spread spectrum technology and channel

hopping for communication security and reliability, as well as TDMA synchronized, latency-controlled communications between devices on the network. This technology has been proven in field trials and real plant installations across a broad range of process control industries.

Each device in the mesh network can serve as a router for messages from other devices. In other words, a device doesn't have to communicate directly to a gateway, but just forward its message to the next closest device. This extends the range of the network and provides redundant communication routes to increase reliability.

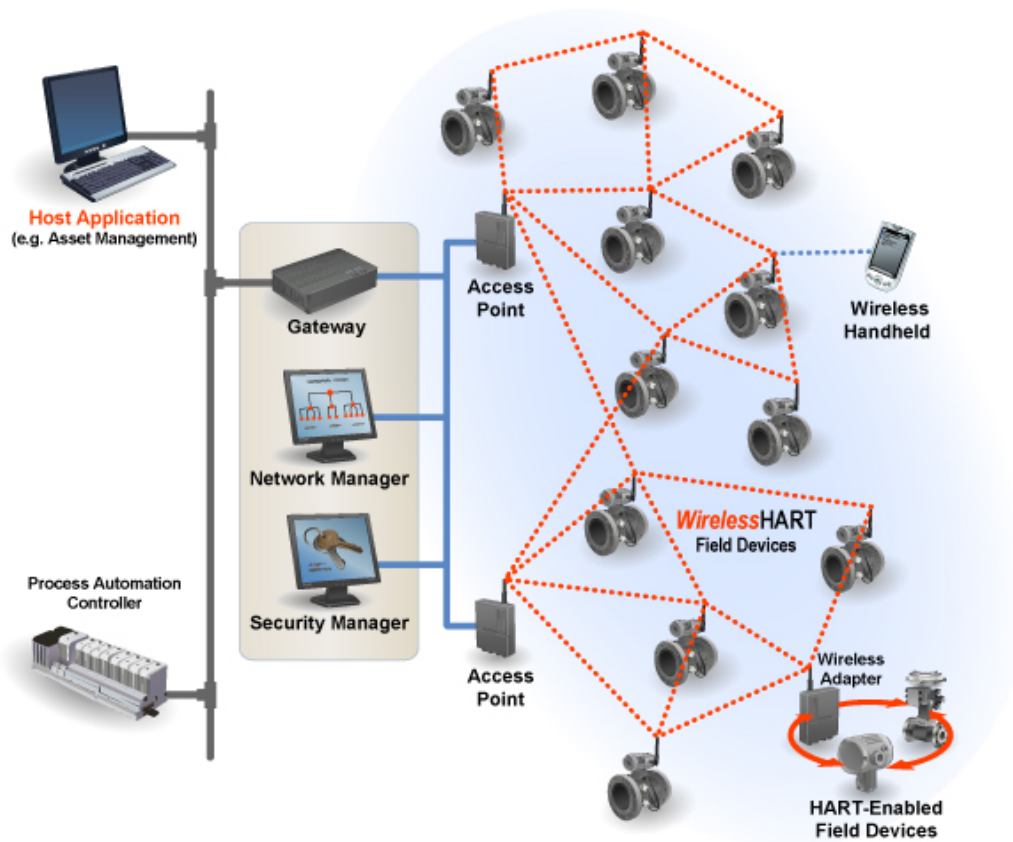

The **Network Manager** determines the redundant routes based on latency, efficiency and reliability. To ensure the redundant routes remain open and unobstructed, messages continuously alternate between the redundant paths. Consequently, like the Internet, if a message is unable to reach its destination by one path, it is automatically re-routed to follow a known-good, redundant path with no loss of data.

The mesh design also makes adding or moving devices easy. As long as a device is within range of others in the network, it can communicate.

For flexibility to meet different application requirements, the *WirelessHART* standard supports multiple messaging modes including one-way publishing of process and control values, spontaneous notification by exception, ad-hoc request/response, and auto-segmented block transfers of large data sets. These

capabilities allow communications to be tailored to application requirements thereby reducing power usage and overhead.

COMPONENTS

Gateway provides the connection to the host network. *WirelessHART* and then the main host interfaces such as Modbus – Profibus – Ethernet. The Gateway also provides the network manager and security manager (these functions can also exist at the host level – but initially they will be in the gateway).

The Network Manager builds and maintains the MESH network. It identifies the best paths and manages distribution of slot time access (*WirelessHART* divides each second into 10msec slots). Slot access depends upon the required process value refresh rate and other access (alarm reporting – configuration changes).

The **Security Manager** manages and distributes security encryption keys. It also holds the list of authorized devices to join the network.

The **Process** includes measuring devices – the HART-enabled instrumentation.

A **Repeater** is a device which routes *WirelessHART* messages but may have no process connection of its own. Its main use would be to extend the range of a *WirelessHART* network or help “go around” an existing or new obstacle (new process vessel). All instruments in a *WirelessHART* network have routing capability which simplifies planning and implementation of a wireless network.

The **Adapter** is a device which plugs into or attaches to an existing HART-enabled instrument to pass the instrument data through a *WirelessHART* network to the host. The adapter could be located anywhere along the instrument 4-20mA cable; it could be battery powered or obtain its power from the 4-20mA cable. Some adapters will be battery powered and use the same battery to power the instrument as well – in this case there will be no 4-20mA signal to the host – all process data will be reported via *WirelessHART*

A **Handheld Terminal** may come in two versions.

1) The handheld will be a standard HART FSK configuration unit (just add new device DDs or DOF files) just like the one used for everyday tasks such as routine maintenance and calibration checks. In the case of wireless support, the handheld is used to join a new instrument to an existing *WirelessHART* network.

2) The handheld has a *WirelessHART* connection to the gateway and then down to an instrument and could be used for reading PV or diagnostics.

GETTING STARTED

WirelessHART technology brings a new dimension to the world of process automation. Building on the proven success of the HART Protocol, *WirelessHART* extends the reach of process instrumentation in a way that is compatible with existing systems and practices.

Let's review the straight-forward steps needed to ensure a successful *WirelessHART* installation.

Planning a *WirelessHART* Project

1. Scope of Project
 - a. What are the objectives for the project – PV monitoring, non-critical control or instrument condition monitoring. The answer to this question will affect the devices you select - battery powered instruments or *WirelessHART* adapters, for example. As part of the scope, be sure to review: area of network coverage, density of the area and primary and secondary instrumentation.
2. Planning the Network
 - a. There are several ways by which you can plan a network and allocate devices. They are similar to those used when allocating instruments to I/O cards in a PLC/Controller however there are some new considerations such as gateway placement and update rates.
 - b. *WirelessHART* could have little impact here however there will be some things that are new. For example, the instrument data sheet and I/O schedule will need to reflect new information such as Network-ID – Join Key – Refresh Rate.
3. Host Integration
 - a. Here the emphasis is upon using existing protocols (Modbus – Profibus) for host integration and existing tools for instrument configuration. The new consideration is security – which is built-in!

Device Placement

Don't forget this is a mesh network. Instruments do not need to be within the range of the gateway but rather just need to be close to another wireless instrument.

Tips for Network Planning:

- Locate instruments based upon segmentation criteria
- Check coverage via scaled site drawings
- Locate repeaters as required
- Can the gateway can be moved into the plant (check for necessary certification)
- Use directional or remote antenna if needed

Device Specification

WirelessHART devices are all basically the same when it comes to their wireless characteristics. The device should be registered with the Foundation which is an indicator of a good wireless design and interoperability with other suppliers' products.

Verify the range of the antenna since some devices may offer antenna options that will alter the distance assumptions.

Factory Configuration - Decide if you want the network ID and join key entered by your supplier (if offered).

Commissioning and Checkout

Planning a *WirelessHART* network is a fairly simple process. Common sense rules provide the guidance for a successful installation. Here are a few things to remember:

A HART handheld or PC tool will allow you to join instruments to the network. Overlapping networks will have different network IDs.

1. Steps – the Gateway
 - a. Install and power Gateway
 - b. Install devices one by one
 - Begin with closest to the gateway

2. Steps – the *WirelessHART* Device
 - a. Install or activate the device's power source
 - b. Enter the Network ID
 - c. Enter the Network Join Key
 - d. Set the refresh (update) rate
 - e. Verify the device has joined the network
 - At the device using a handheld or other tool
 - At the gateway

3. Steps – Commissioning a *WirelessHART* device
 - Verify Device Operation
 1. Check device TAG
 2. Check device engineering units
 3. Check PV Update rate
 4. Check battery voltage
 - Verify Gateway
 1. Check for minimum of 5 direct connections
 2. Check for 25% of devices with direct connections in large networks with <10% add repeaters if necessary

Commissioning a *WirelessHART* network

After all devices have been commissioned, allow time for the network to optimize (>4 hours). Check each device for at least 3 neighbors and check path stability for 60% minimum. Increasing the elevation of the antenna can correct many situations. Add a repeater if necessary.

Security

Allowing Access to the Network through Key Management (including Network ID Key Management) includes a global key for all devices, individual key for each device, Join Key – Fixed, Rotating or

Assignment at the factory with order or on the bench. White Lists may include only “approved” devices allowed or require an approval procedure.

Best Practices

- Each field device has at least 3 neighbors. The 3rd neighbor will act as a backup if one of the two primary paths is obstructed or unavailable
- Devices (antenna) mounted >0.5m from any vertical surface
- Devices mounted >1.5m off the ground
- Gateway should have at least 5 neighbors
- 25% of the network devices should have a direction connection to the gateway in large networks

BENEFITS OF HART COMMUNICATION

The HART Protocol is a powerful communication technology used to exploit the full potential of digital field devices. Preserving the traditional 4-20mA signal, the HART Protocol extends system capabilities for two-way digital communication with smart field instruments.

The HART Protocol offers the best solution for smart field device communications and has the widest base of support of any field device protocol worldwide. More instruments are available with the HART Protocol than any other digital communications technology. Almost any process application can be addressed by one of the products offered by HART instrument suppliers.

Unlike other digital communication technologies, the HART Protocol provides a unique communication solution that is backward compatible with the installed base of instrumentation in use today. This backward compatibility ensures that investments in existing cabling and current control strategies will remain secure well into the future.

Benefits outlined in this section include:

- Improved plant operations including cost savings
- Operational flexibility
- Instrumentation investment protection

IMPROVED PLANT OPERATIONS

The HART Protocol improves plant performance and increases efficiencies in:

- Commissioning and installation
- Plant operations
- Maintenance

COST SAVINGS IN COMMISSIONING

HART-based field devices can be installed and commissioned in a fraction of the time required for a traditional analog-only system or other field protocols. Operators who use HART digital communications can easily identify a field device by its tag and verify that operational parameters are correct. Configurations of similar devices can be copied to streamline the commissioning process. A loop integrity check is readily accomplished by commanding the field transmitter to set the analog output to a preset value.

COST SAVINGS IN INSTALLATION

The HART Protocol supports the networking of several devices on a single twisted wire pair. This configuration can provide significant savings in wiring, especially for applications such as tank monitoring.

Multivariable devices reduce the number of instruments, wiring, spare parts, and terminations required. A single device can provide multiple measurements eliminating the need for additional wires. Some HART field instruments embed PID control, which eliminates the need for a separate controller, and results in significant wiring and equipment cost savings.

DIGITAL COMMUNICATION

A digital instrument that uses a microprocessor provides many benefits. These benefits are found in all smart devices regardless of the type of communication used. A digital device provides advantages such as improved accuracy and stability. The HART Protocol enhances the capabilities of digital instruments by providing communication access and networking (Table 2).

Benefits	HART Instruments	Digital Instruments
Accuracy and stability	✓	✓
Reliability	✓	✓
Multivariable	✓	✓
Computations	✓	✓

Benefits	HART Instruments	Digital Instruments
Diagnostics	✓	✓
Multiple sensor inputs	✓	✓
Ease of commissioning	✓	
Tag ID	✓	
Remote configuration	✓	
Loop checks	✓	
Adjustable operational parameters	✓	
Access to historical data	✓	
Multi-drop networking	✓	
Access by multiple host devices	✓	
Extended communication distances	✓	
Field-based control	✓	
Interoperability	✓	

Table 2 – Digital Instruments vs. HART Instruments

IMPROVED MEASUREMENT QUALITY

HART-communicating devices provide accurate information that helps improve the efficiency of plant operations. During normal operation, device operational values can be easily monitored or modified remotely. If uploaded to a software application, these data can be used to automate record keeping for regulatory compliance (e.g., environmental, validation, ISO9000, and safety standards).

Numerous device parameters are available from HART-compatible instruments that can be communicated to the control room and used for control, maintenance, and record keeping (Fig 6).

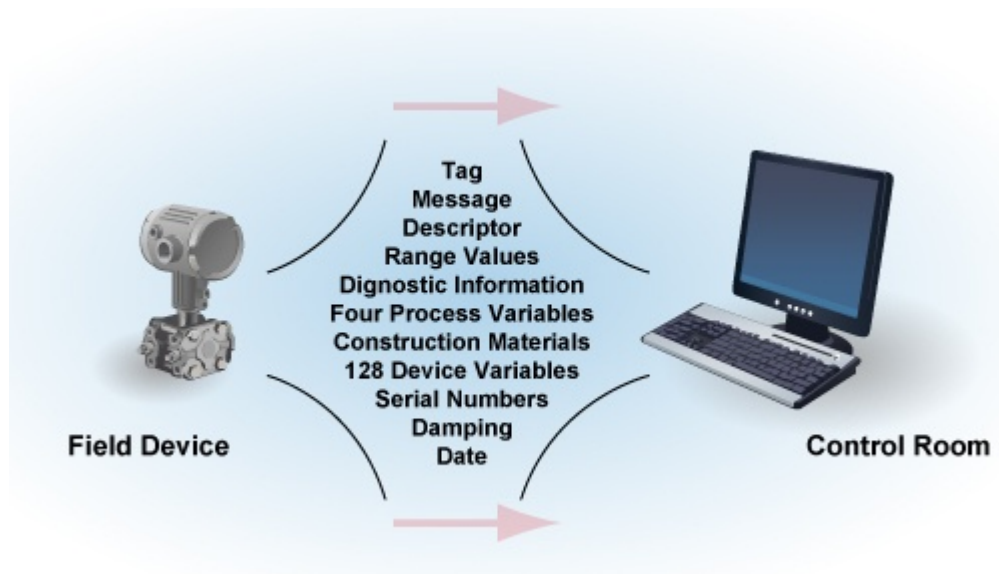

Figure 6 – Examples of Device Parameters Sent to Control Room

Some HART devices perform complex calculations, such as PID control algorithms or compensated flow rate. Multivariable HART-capable instruments take measurements and perform calculations at the source, which eliminates time bias and results in more accurate calculations than are possible when performed in a centralized host.

The HART Protocol provides access to all information in multivariable devices. In addition to the analog output (Primary Variable), the HART Protocol provides access to all measurement data that can be used for verification or calculation of plant mass and energy balances.

Some HART field devices store historical information in the form of trend logs and summary data. These logs and statistical calculations (e.g., high and low values and averages) can be uploaded into a software application for further processing or record keeping.

COST SAVINGS IN MAINTENANCE

The diagnostic capabilities of HART-communicating field devices can eliminate substantial costs by reducing downtime. The HART Protocol communicates diagnostic information to the control room or asset management system, which minimizes the time required to identify the source of any problem and to take corrective action. Trips into the field or hazardous areas are eliminated or reduced.

When a replacement device is put into service, HART communication allows the correct operational parameters and settings to be uploaded quickly and accurately into the device from a central database. Efficient and rapid uploading reduces the time that the device is out of service. Some software applications provide a historical record of configuration and operational status for each instrument. This information can be used for predictive, preventive and proactive maintenance.

OPERATIONAL FLEXIBILITY

The HART Protocol allows two masters (primary and secondary) to communicate with slave devices and provide additional operational flexibility. A permanently connected host system can be used simultaneously, while a handheld terminal or PC controller is communicating with a field device (Fig 7).

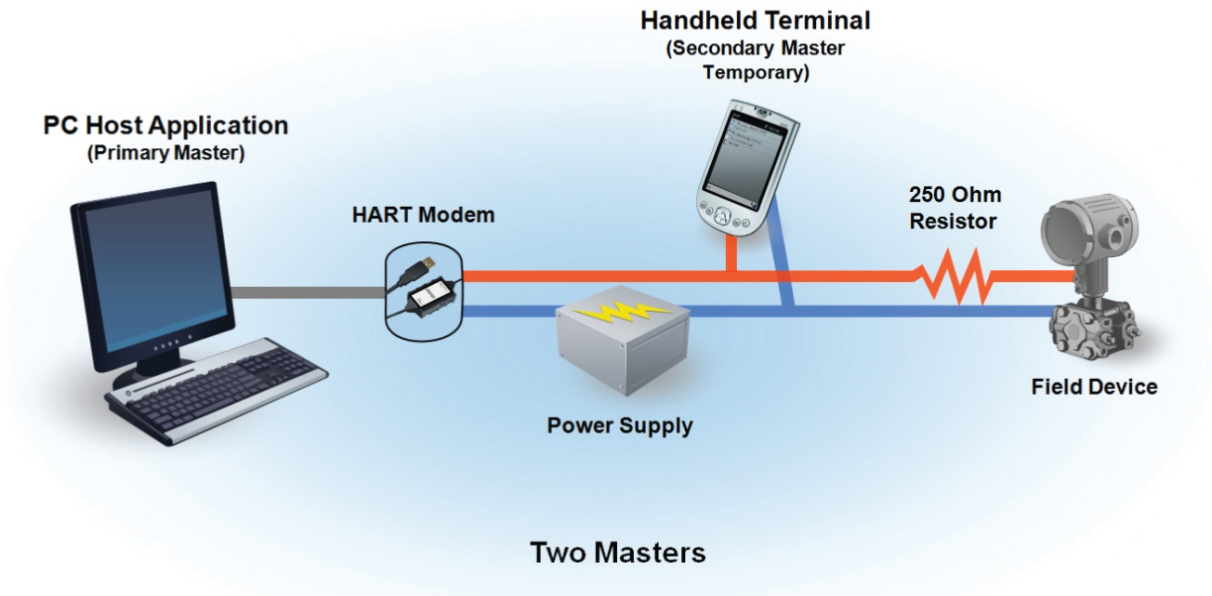

Figure 7 - Communication with Two Masters

The HART Protocol ensures interoperability among devices through Universal Commands that enable hosts to easily access and communicate the most common parameters used in field devices. The HART EDDL (Enhanced Device Description Language) extends interoperability to include information that may be specific to a particular device. EDDL enables a single handheld configurator or PC host application to configure and maintain HART-communicating devices from any manufacturer. The use of common tools for products of different vendors minimizes the amount of equipment and training needed to maintain a plant.

Device and Host Interoperability is also insured by a rigorous device testing and registration program.

HART technology extends the capability of field devices beyond the single-variable limitations of 4-20mA in hosts with HART capability.

INSTRUMENTATION INVESTMENT PROTECTION

Existing plants and processes have considerable investments in wiring, analog controllers, junction boxes, barriers, marshalling panels, and analog or smart instrumentation. The people, procedures and equipment already exist for the support and maintenance of the installed equipment. HART field instruments protect this investment by providing compatible products with enhanced digital capabilities. These enhanced capabilities can be used incrementally.

The HART Communication Protocol enables you to retain your previous investments in existing hardware and personnel

At the basic level, HART devices communicate with a handheld terminal for setup and maintenance. As needs grow, more sophisticated on-line, PC-based systems can provide continuous monitoring of device status and configuration parameters. Advanced installations also can use control systems with HART I/O capability. The status information can be used directly by control schemes to trigger remedial actions and allow on-line re-ranging based on operating conditions and direct reading of multivariable instrument data.

COMPATIBILITY OF HART REVISIONS

As HART field devices are upgraded, new functions may be added. A basic premise of the HART Protocol is that new HART instruments must behave in precisely the same manner as older versions when interfaced with an earlier revision host system. This backward compatibility protects your investment for years to come.

GETTING THE MOST OUT OF HART SYSTEMS

To take full advantage of the benefits offered by the HART Communication Protocol, it is important that you install and implement the system correctly. The following section contains information that can help you to get the most from your HART system:

- Wiring and Installation
- Intrinsic safety (IS)
- HART multi-drop networks
- Control system interfaces
- Multiplexers
- Reading HART data into non-HART systems
- Commissioning HART networks
- Device status and diagnostics
- Connecting a PC to a HART device or network

WIRING AND INSTALLATION

In general, the installation practice for HART-communicating devices is the same as for conventional 4-20mA instrumentation. Individually shielded twisted pair cable, either in single-pair or multi-pair varieties, is the recommended wiring practice. Unshielded cables may be used for short distances if ambient noise and cross-talk will not affect communication. The minimum conductor size is 0.51 mm diameter (#24 AWG) for cable runs less than 1,524 m (5,000 ft.) and 0.81 mm diameter (#20 AWG) for longer distances.

CABLE LENGTH

Most installations are well within the 3,000 meter (10,000 ft.) theoretical limit for HART communication. However, the electrical characteristics of the cable (mostly capacitance) and the combination of connected devices can affect the maximum allowable cable length of a HART network. Table 3 shows the effect of cable capacitance and the number of network devices on cable length. The table is based on typical installations of HART devices in non-IS environments, i.e. no miscellaneous series impedance. Detailed information for determining the maximum cable length for any HART network configuration can be found in the HART Physical Layer Specifications.

Cable Capacitance – pf/ft (pf/m)				
Cable Length – feet (meters)				
No. Network Devices	20 pf/ft (65 pf/m)	30 pf/ft (95 pf/m)	50 pf/ft (160 pf/m)	70 pf/ft (225 pf/m)
1	9,000 ft (2,769 m)	6,500 ft (2,000 m)	4,200 ft (1,292 m)	3,200 ft (985 m)
5	8,000 ft (2,462 m)	5,900 ft (1,815 m)	3,700 ft (1,138 m)	2,900 ft (892 m)
10	7,000 ft (2,154 m)	5,200 ft (1,600 m)	3,300 ft (1,015 m)	2,500 ft (769 m)
15	6,000 ft (1,846 m)	4,600 ft (1,415 m)	2,900 ft (892 m)	2,300 ft (708 m)

Table 3 – Allowable cable lengths for 1.02 mm (#18 AWG) shield twisted pair

INTRINSIC SAFETY

Intrinsic safety (IS) is a method of providing safe operation of electronic process-control instrumentation in hazardous areas. IS systems keep the available electrical energy in the system low enough that ignition of the hazardous atmosphere cannot occur. No single field device or wiring is intrinsically safe by itself (except for battery-operated, self-contained devices), but is intrinsically safe only when employed in a properly designed IS system.

INTRINSIC SAFETY DEVICES

HART-communicating devices work well in applications that require IS operation. IS devices (e.g., barriers) are often used with traditional two-wire 4-20mA instruments to ensure an IS system in hazardous areas. With traditional analog instrumentation, energy to the field can be limited with or without a ground connection by installing one of the following IS devices:

- *Shunt-diode (zener) barriers* that use a high-quality safety ground connection to bypass excess energy (Fig 8)
- *Isolators*, which do not require a ground connection, that repeat the analog measurement signal across an isolated interface in the safe-side load circuit (Fig 8a).

Both zener barriers and isolators can be used to ensure an IS system with HART-communicating devices, but some additional issues must be considered when engineering the HART loop.

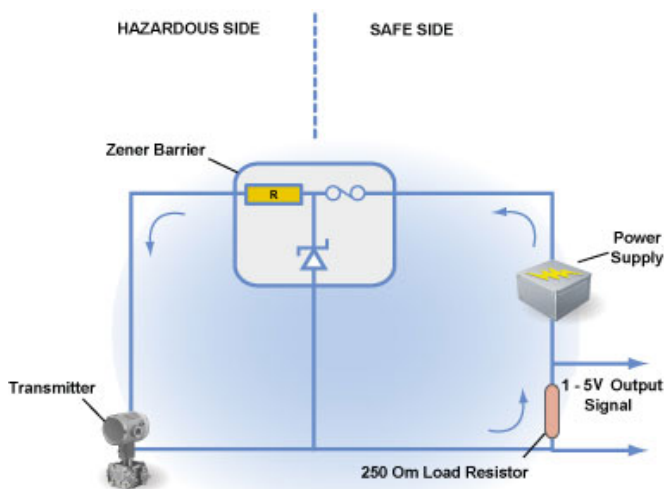

Figure 8 – 4-20mA Loop with Zener Barrier

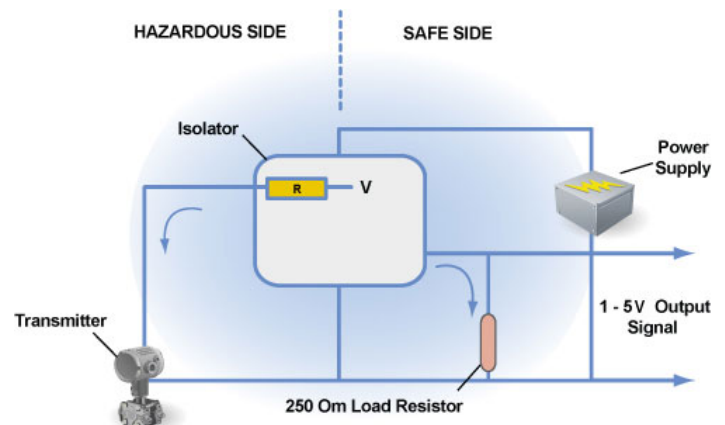

Figure 8 a – 4-20mA Loop with Isolator

DESIGNING AN IS SYSTEM USING SHUNT-DIODE BARRIERS

Designing an IS direct-current loop simply requires ensuring that a field device has sufficient voltage to operate, taking into account zener barrier resistance, the load resistor, and any cable resistance.

When designing an IS loop using shunt-diode barriers, two additional requirements must be considered:

- The power supply must be reduced by an additional 0.7 V to allow headroom for the HART communication signal and yet not approach the zener barrier conduction voltage.
- The load resistor must be at least 230 Ω (typically 250 Ω).

Depending on the lift-off voltage of the transmitter (typically 10–12 V), these two requirements can be difficult to achieve. The loop must be designed to work up to 22mA (not just 20mA) to communicate with a field device that is reporting failure by an upscale, over-range current. The series resistance for the same zener barrier may be as high as 340 Ω . To calculate the available voltage needed to power a transmitter, use the following equation:

- Power Supply Voltage – (Zener Barrier Resistance + Sense Resistance) \times Operating Current (mA)
= Available Voltage

Example: 26.0 V – (340 Ω + 250 Ω) \times 22mA = 13.0 V

Any cable resistance can be added as a series resistance and will reduce the voltage even further. In addition, the power supply to the zener barrier must also be set lower than the zener barrier conduction voltage. For example, a 28 V, 300 Ω zener barrier would typically be used with a 26 V power supply.

While it is difficult to meet the two requirements noted above for a network using shunt-diode barriers, it can be done. Following are two possible solutions to the problem:

1. Shunt the load resistor with a large inductor so that the load resistor impedance is still high (and mainly resistive) at HART signal frequencies, but much lower at direct current. This solution, while it does work, is physically somewhat inconvenient.
2. Use an IS isolator rather than a shunt-diode barrier. The output voltage on the hazardous side is usually specified as *greater than X Vdc at 20mA* (typically 14-17 V). This value already includes the voltage drop due to the internal safety resistor, so the only extra voltage drop is that due to cable resistance. System operation at 22mA requires reducing the 20mA voltage by 0.7 V (340 Ω \times 2mA).

DESIGNING AN IS SYSTEM USING ISOLATORS

The implementation of HART loops in an IS system with isolators requires more planning. An isolator is designed to recreate the 4-20mA signal from the field device in the safe-side load circuit. Most older isolator designs will not carry the high frequencies of HART current signals across to the safe side, nor will they convey HART voltage signals from the safe side to the field. For this reason, HART

communication through the isolator is not possible with these older designs. (It is still possible to work with a handheld communicator or a PC with an IS modem on the hazardous side of the isolator.) When retrofitting HART instruments into an existing installation, inspect the system for isolators that may have to be replaced (any isolators that will not support HART signals).

Major suppliers of IS isolators have introduced designs that are fully HART compatible. Modern IS isolators provide trouble-free design and operation and transparent communication in both directions.

IS device suppliers can assist with certification and performance specifications for their HART-compatible products. Field device manufacturers will also supply certification details for their specific products.

MULTI-DROP IS NETWORKS

HART multi-drop networks are particularly suitable for intrinsically safe installations. With a multi-drop configuration, fewer barriers or isolators are required. In addition, because each field device takes only 4mA (for a total of 16mA in a four-device loop) plain zener barriers can be used. With a 250 Ω load, 25 V – $(340 + 250 \Omega \times 16mA = 15.5 V$, which is well above the transmitter lift-off voltage and leaves a margin for cable resistance.

IS OUTPUT LOOPS

For output devices such as valve positioners, direct-current voltage considerations will vary depending on the drive requirements of the device. Zener barriers may be possible. If not, modern HART-compatible output isolators are appropriate.

IS CERTIFICATION CONSIDERATIONS

If the HART loop contains an IS-approved handheld communicator or modem, slight changes may be needed to meet IS Installation Certification. Handheld communicators and modems add the HART signal voltage to the voltage level coming from the zener barrier or isolator. For example, a handheld communicator typically adds a maximum of 2V to the loop. Therefore, when used with a 28V zener barrier, a total of 30V may theoretically be present in the loop. The allowable capacitance must be reduced by about 15% to account for this increase in voltage.

IS NETWORK CABLE LENGTH CALCULATIONS

The cable length calculation must include the resistance of both the zener barrier and the load resistor.

SAFETY INTEGRITY LEVEL (SIL)

When performing a risk analysis on a process operation, each loop is analyzed for its potential contribution to an unsafe condition should a failure occur. This assessment will define an acceptable Safety Integrity Level (SIL) for each loop in that process. Using continuous HART Communication allows the diagnosis of potentially dangerous failures and conditions to be significantly increased which increases the SIL.

Every device in a loop has potential failure conditions. Sometimes increased maintenance will insure a higher degree of reliability. For many devices, online diagnoses of failures or potentially dangerous conditions are required to insure the level of reliability demanded by the SIL of the process.

It is up to the design team to select the proper products and procedures to demonstrate the achievement of the required SIL. Guidelines are offered in the ISA Standard SP84.01 and in the IEC standard 61508 for methods to improve loop reliability.

HART MULTI-DROP NETWORKS

The HART Communication Protocol enables several instruments to be connected on the same pair of wires in a *multi-drop network* configuration (Fig 9). The current through each field device is fixed at a minimum value (typically 4mA) sufficient for device operation. The analog loop current does not change in relation to the process and thus does not reflect the primary variable. Communications in multi-drop mode are entirely digital.

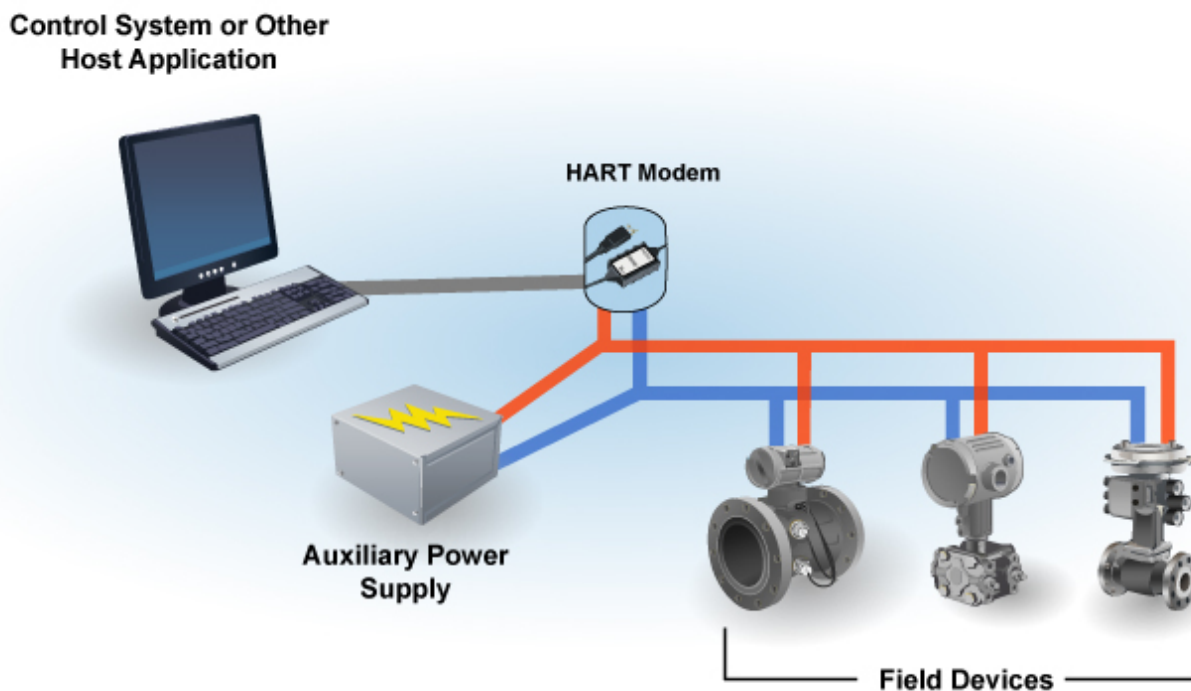

Figure 9 – Multi-drop Configuration

Standard HART commands are used to communicate with field instruments to determine process variables or device parameter information (see *HART Commands* on page 19). The typical cycle time needed to read information on a single variable from a HART device is approximately 500 milliseconds (ms). For a network of 15 devices, a total of approximately 7.5 seconds is needed to scan and read the primary variables from all devices. Reading information from multivariable instruments may take longer, as the data field will typically contain values for four variables rather than just one.

The typical multi-drop network enables two-wire measurement devices to be connected in parallel. Two-wire loop-powered and four-wire active-source devices can be connected in the same network. If both two- and four-wire devices are used in the same network, three wires must be used to properly connect the devices (see *Water Treatment Facility Upgrade* on page 157).

MULTI-DROP WITH HART FIELD CONTROLLERS

HART field controllers can also be wired in a multi-drop network (Fig 10). Each analog output signal from the transmitter/controllers is isolated from every other output signal, which provides a cost-effective HART network configuration. In this case, the analog signals are not fixed and are used for the output signal to the controlled device.

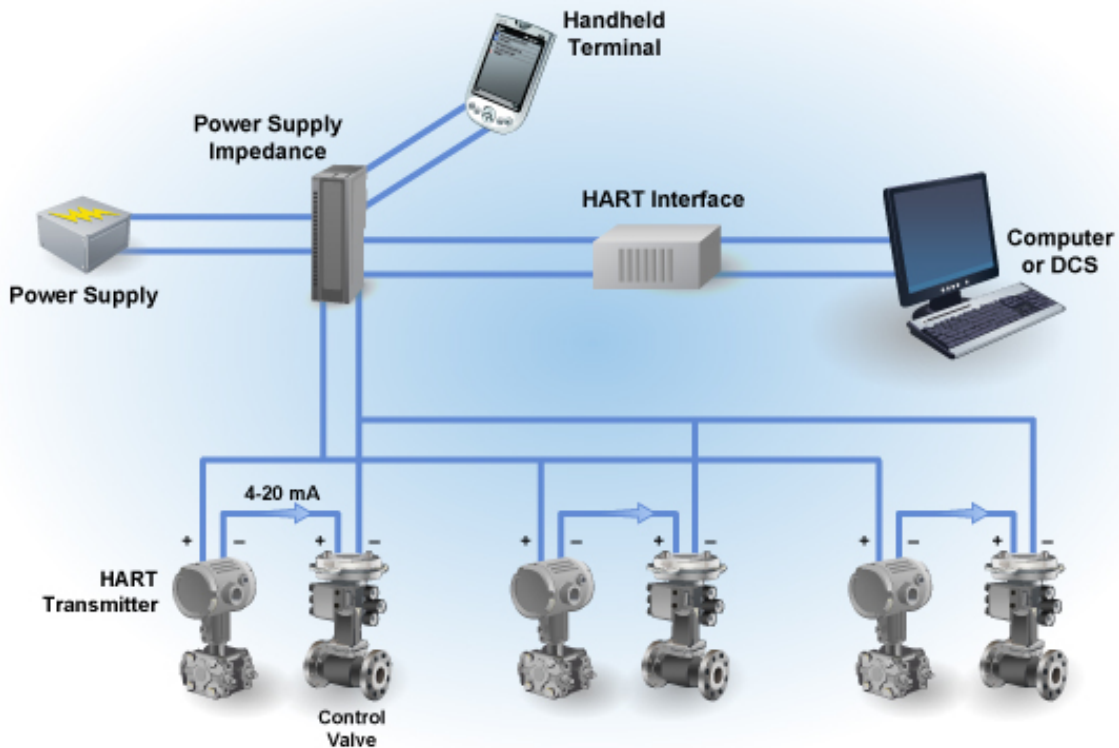

Figure 10 - HART Controllers with Multi-drop

APPLICATION CONSIDERATIONS

Connecting HART field devices in a multi-drop network can provide significant installation savings. The total cable length in a multi-drop network is typically less than the maximum cable length in point-to-point connections because the capacitance of the additional devices reduces the distance that the HART signal can be carried (see *Wiring and Installation* section).

To save on installation costs, use HART multi-drop networks for remote monitoring stations, tank farms, pipeline distribution systems, and other monitoring applications in which fast update rates are not required.

CONFIGURING DEVICES FOR MULTI-DROP OPERATION

Using the polling address structure of the HART Protocol, up to 15 devices can be connected in a multi-drop network. The analog current of a HART device can be fixed by setting its polling address to a number other than zero (0). With the HART Protocol, each field instrument should be configured with different polling addresses or tag numbers before being connected to a multi-drop network—otherwise, the master will not be able to establish communication with the slave devices.

CONTROL SYSTEM INTERFACES

When you change your existing control system by adding a HART interface, it is important to understand the complete functionality offered by the HART interface. While several control system suppliers offer HART interfaces, not all interfaces provide the same functionality.

Control systems such as a DCS (distributed control system), PLC (programmable logic controller), or SCADA/RTU (remote terminal unit) implement only the functionality required for a given application. For example, a flow control system may only read the primary variable of a device and provide no additional support for viewing or changing configuration information. Other control system interfaces provide comprehensive HART support, maintaining complete configuration records for all connected devices.

*Contact your system supplier for specific details on their HART interface(s). Use the **HART Host System Capabilities Checklist** (Appendix A) to obtain information from control system suppliers to identify specific characteristics of their products.*

HART I/O SUBSYSTEMS

Many HART-compatible I/O subsystems have multiple analog channels on each I/O card. Suppliers choose whether to provide one HART interface per channel or to share one HART interface among several channels. The number of shared channels per HART interface impacts the frequency of data updates from a HART field device and the HART functionality that is supported.

HART I/O FOR MULTI-DROP SUPPORT

For the best performance and flexibility, one HART interface should be dedicated to each I/O channel. Systems that share only one HART interface among several I/O channels may not support multi-drop networks. The effective update rate of a multiplexed interface is slow enough that the performance of multiplexed multi-drop networks would not be practical. Some suppliers enable multi-drop support by fixing the HART interface to one specific I/O channel. However, the other channels on that card may then not be available for HART communication.

HART I/O FOR BURST MODE SUPPORT

Burst mode is an optional implementation in a field device. Receiving burst mode messages is optional in a host as well. To take full advantage of burst mode, the I/O system should have one HART interface for each channel. If the HART interface is shared by more than one channel, messages sent by the field device may not be detected by the control system. If the system does not have the ability to configure burst mode in the field device, a handheld terminal or other configuration tool is required.

DATA HANDLING

All HART-compatible control systems can read the digital primary variable from a slave device. However, some system architectures may not be able to accommodate textual data (e.g., tag and descriptor fields). In these cases, the controller is able to read the process variable, but may not have direct access to all other data in the HART device.

PASS-THROUGH FEATURE

Some control systems are integrated with a configuration or instrument management application. In these systems, the control system passes a HART command, issued by the management application, to the field device via its I/O interface. When the control system receives the reply from the field device, it sends the reply to the management application. This function is referred to as a *pass-through feature* of the control system.

GATEWAYS

Gateways can be used to bring HART digital data into control systems that do not support HART-capable I/O. Some systems support HART gateways with communication protocols such as Modbus, PROFIBUS DP, or TCP/IP Ethernet. The typical HART gateway supports all Universal Commands and a subset of the Common Practice Commands. Support varies depending on the gateway supplier. Some gateways support access to Device Specific information.

SCADA/RTU SYSTEMS

RTUs used in SCADA systems use a special telemetry to communicate with the control system. RTUs have the same considerations regarding multi-drop and burst mode support as other systems. However, implementation is made more complex because RTUs often communicate to an upper-level host using a communication protocol other than HART (e.g., Modbus). While there are many benefits to implementing HART in an RTU (support of multi-drop, burst mode, and multivariable instruments), HART data are only available to the central host system if the telemetry protocol supports the transfer of HART commands or specific HART data (see *Multi-drop for Tank Farm Monitoring – Page 60*).

MULTIPLEXERS

HART-compatible multiplexers are ideal for users who want to interface with a large number of HART devices. Multiplexers can be modular and are capable of supporting both point-to-point and all-digital (multi-drop) HART communication modes. Communication between a multiplexer and a host application depends on the multiplexer capabilities (e.g., RS232C, RS485, Modbus, and TCP/IP Ethernet).

When installing HART multiplexer systems, the following capabilities should be considered:

- Number of HART channels supported
- Number of HART channels that share a HART modem
- Burst mode support
- Multi-drop support
- Method of communication with the host computer or control system

MULTIPLEXERS – REMOTE I/O AS THE PRIMARY I/O SYSTEM

HART multiplexers can be used as the primary I/O front end for a HART-based control or monitoring system (Fig 11). Typically, a PC acts as the host, providing the human-machine interface (HMI) and performing other high-level functions. The multiplexer continuously monitors the field devices, reports the current readings and instrument status to the host, and passes HART commands from the host computer to the field devices.

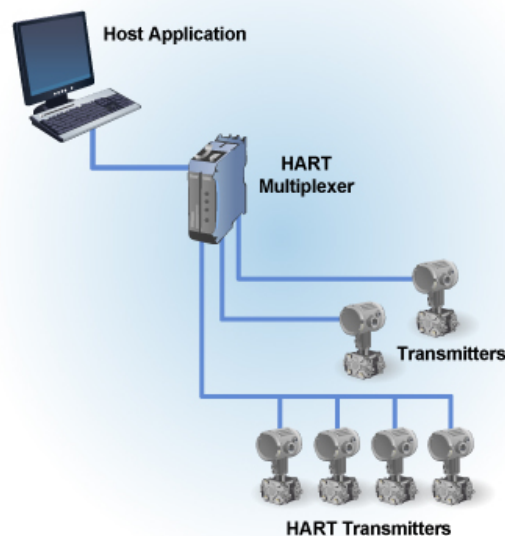

Figure 11 – HART Multiplexer as the Primary I/O System

PARALLEL MONITORING WITH A MULTIPLEXER

When a traditional 4-20mA control system is using the analog signals for measurement and control outputs, a HART multiplexer can be added to the network to gain access to the digital HART signal. Using a multiplexer enables a supervisory computer to monitor diagnostics and device status, access configuration information, and read any additional process inputs or calculations not provided by the 4-20mA signal.

Use a HART multiplexer to gain access to the digital HART signal

Two types of multiplexers are used in conjunction with a control system. A multiplexer wired in parallel with the field wiring is commonly used when the control system wiring is already in place (Fig 12).

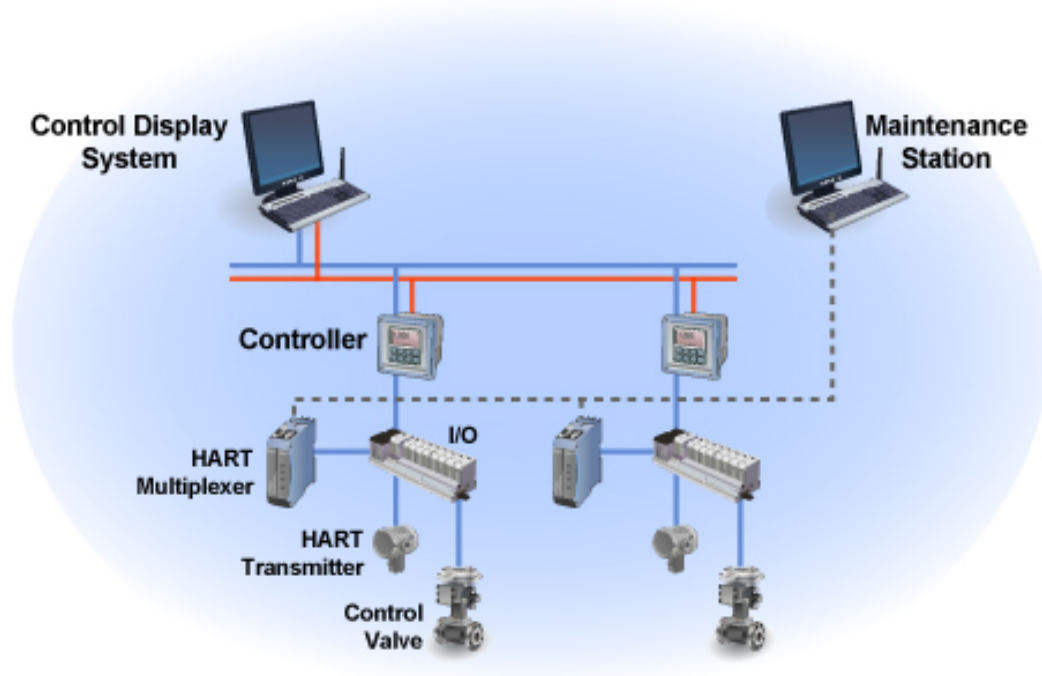

Figure 12 – HART Multiplexer with Existing I/O

A multiplexer can also be an integral part of the control system as a third-party I/O (Fig 13). As an I/O system, the multiplexer can include IS barriers and other filtering capabilities and provide services to the field device, such as galvanic isolation or power. For this type of installation, no additional terminations

or space are required. The multiplexer can also act as a gateway to convert the HART messages to another protocol such as Modbus, PROFIBUS, or Ethernet.

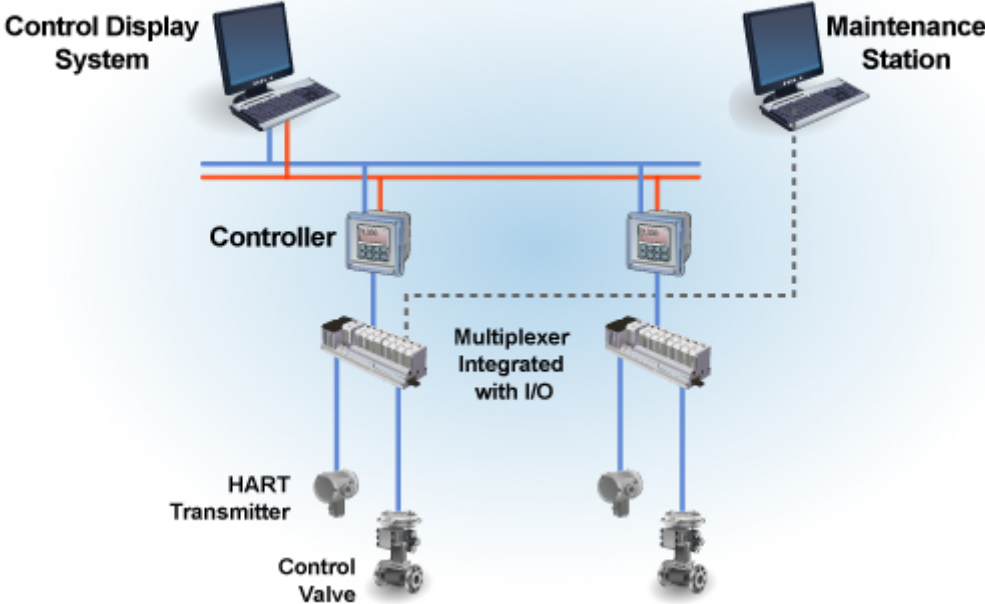

Figure 13 – HART Multiplexer Integrated with I/O

HART OVER PROFIBUS

HART field devices can be seamlessly integrated with PROFIBUS DP networks using the HART/DP Link, which enables the connection of four HART devices and facilitates the pass-through of HART commands to host applications on the DP network (Fig 14). The HART/DP Link supports IS installations.

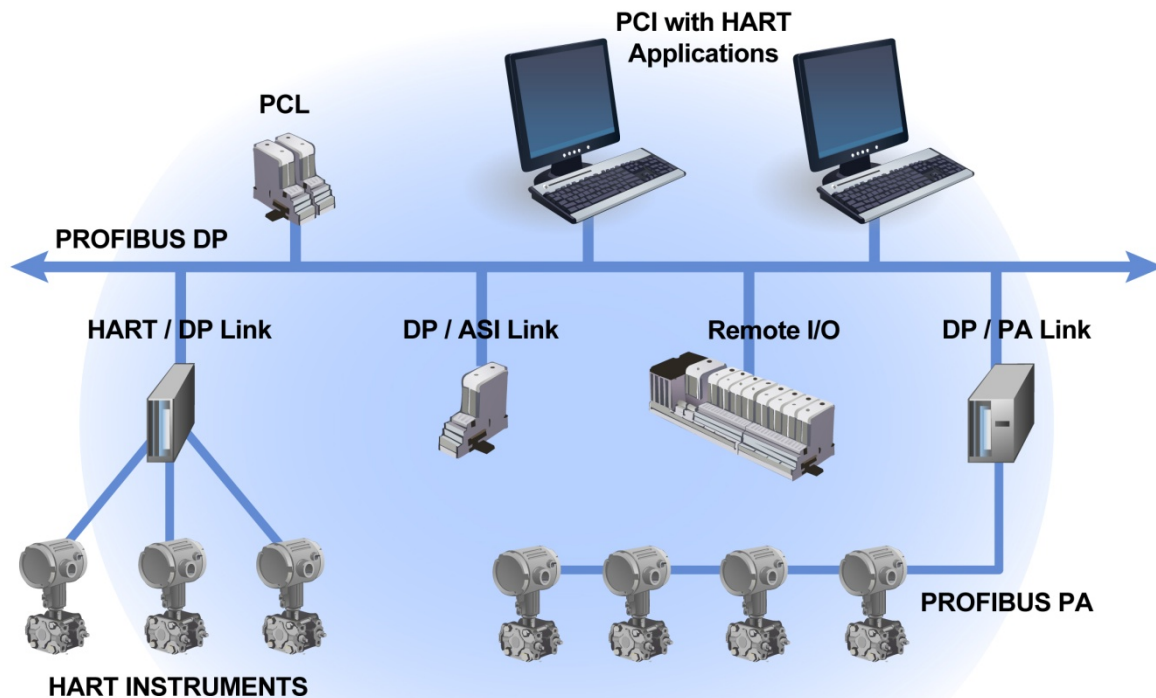

Figure 14 – HART over PROFIBUS

READING HART DATA INTO NON-HART SYSTEMS

Many HART products are able to perform more than one measurement or output function (e.g., make multiple process measurements, calculate process information, and provide positioner feedback information). All of this information can be easily accessed digitally. However, existing controllers or interface equipment may not have the ability to read digital HART data. Products are available that can read HART digital signals and convert them to analog (4-20mA) and alarm trip (contact closure) information, which enables any traditional analog control system to take full advantage of the benefits of HART-communicating devices.

The HART loop monitor continuously communicates with any HART-capable device and provides multiple analog outputs (4-20mA) and multiple alarm trip (contact closure) outputs based on the information received (Fig 15). For example, smart HART multivariable mass flow transmitters sense three process variables (pressure, temperature, and differential pressure or raw flow). Using these, they perform an internal calculation to derive mass flow. The mass flow information is transmitted as a 4-20mA signal to the control system. However, there is no way to continuously monitor the non-primary variables used to make the calculation.

Installed transparently across the 4-20mA instrument loop, the HART loop monitor reads the HART digital data that is continuously being transmitted on the smart transmitter's analog loop wires, and converts it to 4-20mA signals that can be readily accepted by a DCS (distributed control system) or PLC (programmable logic controller). This allows continuous tracking of a multivariable transmitter's second, third and fourth variables. HART loop monitors can also provide alarm trip (contact closure) information to warn of high and/or low process conditions based on user-set trip points. Diagnostic alarms can be set to warn of problems with a smart HART transmitter using the Field Device Status data that is available in HART digital information.

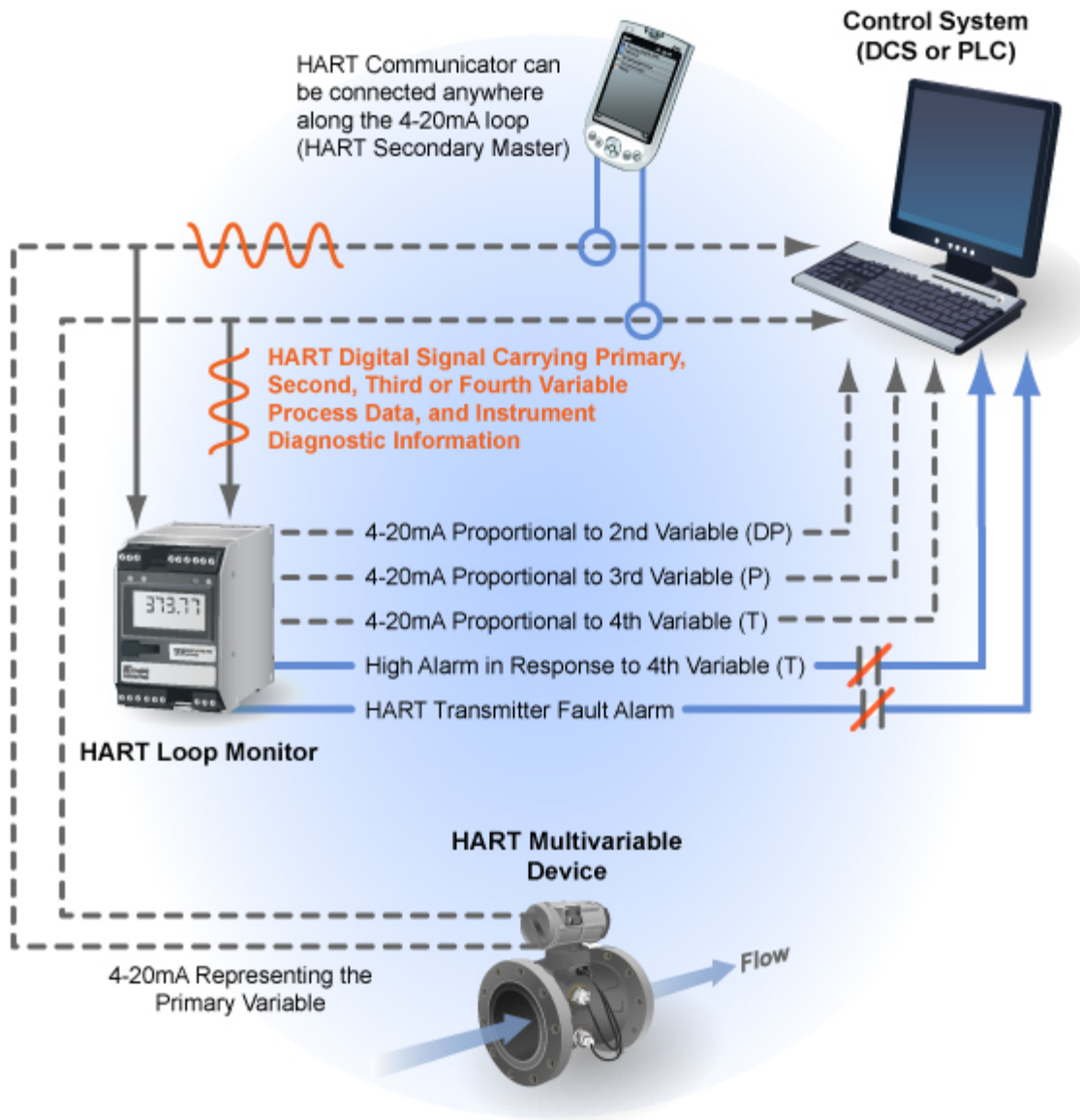

Figure 15 – Monitoring Multivariable Transmitters

HART loop monitors also can extract data from smart HART valve positioners and damper operators (Fig 16). Their 4-20mA analog outputs can be used to keep track of important parameters such as valve stem position, actuator pressure or temperature. Alarm (relay) outputs can also be set to alert of a smart valve condition such as valve position (open/closed), low actuator pressure, and positioner temperature (high/low).

For on-line testing of Emergency Shutdown valves, the HART loop monitor can be used to verify that the valve is operational without the disruption of completely closing the valve (which is the traditional way to verify ESD valve operation) by means of partial valve stroke testing.

For example, a Logic Solver (DCS or PLC) is used to apply a 90% (18.4mA) signal to the valve. When the valve reaches the 90% set point, the relay in the HART loop monitor will trip to verify that the valve has reached 90%. The test signal is then returned to 100% value by the Logic Solver, and the valve is reopened. A second HART loop monitor relay trip is set at 100% (full open) travel to ensure that the valve did reopen completely after the test. This procedure verifies that the valve did reach 90%, proving that the valve is not stuck. Because the valve was immediately reopened, the test has not impeded the process flow long enough to cause significant process disruption.

The HART loop monitor's other analog outputs can be used to provide status information for other important valve parameters such as valve travel and valve output pressure.

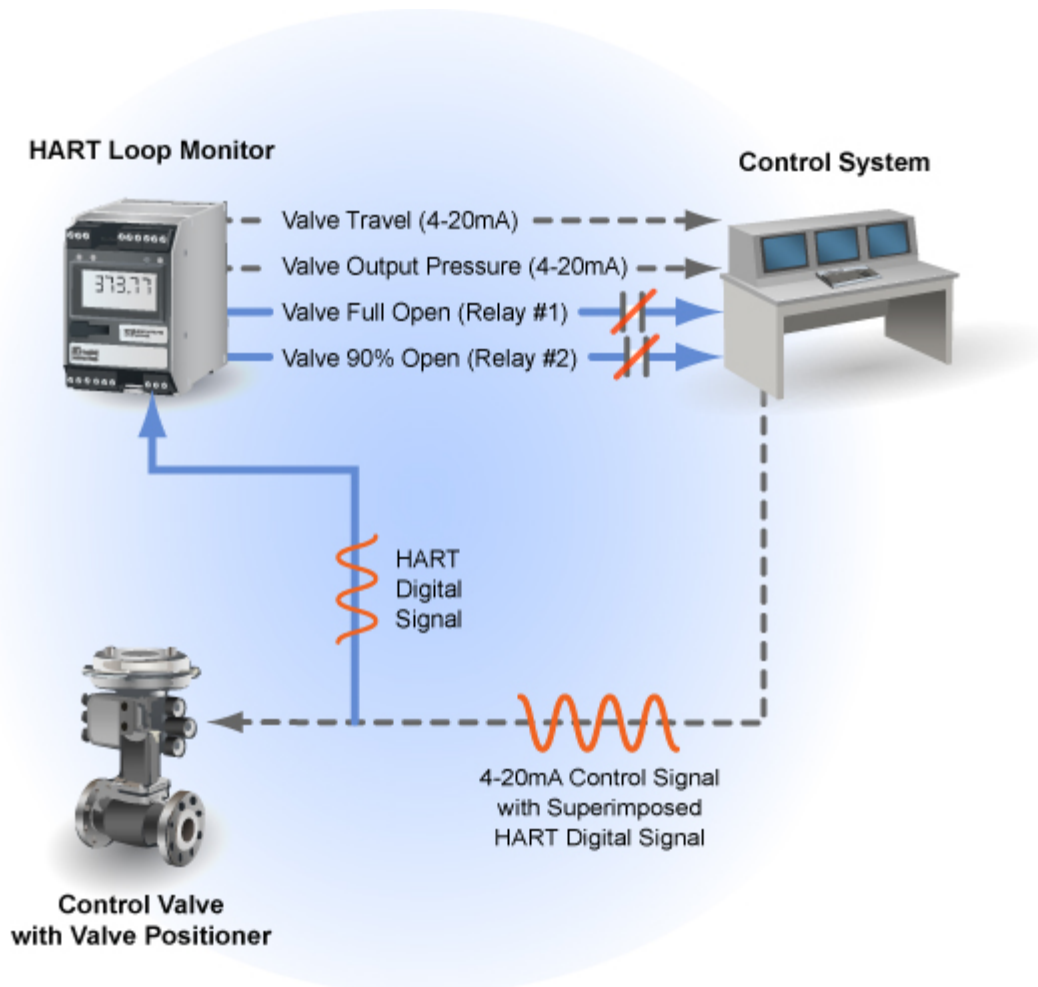

Figure 16 – Monitoring Partial Valve Stroke Testing

COMMISSIONING HART NETWORKS

HART-based instruments have several features that significantly reduce the time required to fully commission a HART network (loop). When less time is required for commissioning, substantial cost savings are achieved.

DEVICE VERIFICATION

Before installation, manufacturers usually enter device tags and other identification and configuration data into each field instrument. After installation, the instrument identification (tag and descriptor) can be verified in the control room using a configurator (handheld terminal or PC). Some field devices provide information on their physical configuration (e.g., wetted materials)—these and other configuration data can also be verified in the control room. The verification process can be important in conforming to governmental regulations and ISO quality requirements.

The commissioning process can be further streamlined by connecting a PC configurator to each HART loop online, either by integration with the control system or by using one of the many available HART multiplexing I/O systems (see *Multiplexers*). With this centralized approach, there is no need to move the configuration device from one termination point to the next while commissioning all devices on the network.

LOOP INTEGRITY CHECK

Once a field instrument has been identified and its configuration data confirmed, the analog loop integrity can be checked using the loop test feature, which is supported by many HART devices. The loop test feature enables the analog signal from a HART transmitter to be fixed at a specific value to verify loop integrity and ensure proper connection to support devices such as indicators, recorders, and DCS displays.

Use the HART Protocol loop test feature to check analog loop integrity and ensure a proper physical connection among all network devices.

AS-INSTALLED RECORD KEEPING

A HART configurator also facilitates record keeping as installed device configuration data can be stored in memory or on a disk for later archiving or printing.

DEVICE STATUS AND DIAGNOSTICS

Most HART field instruments provide both status information and diagnostic information. The HART Protocol defines *basic status information* as information that is included with every message from a field device. Basic status information enables the host application to immediately identify warning or error conditions detected by the field device.

Status messages also enable the user to differentiate between measurements that are outside sensor or range limits and actual hardware malfunctions. Examples of status messages are:

- Field device malfunction
- Configuration changed
- Cold start
- More status available
- Analog output current fixed
- Analog output saturated
- Non-primary variable out of limits
- Primary variable out of limits

HART instruments can implement extensive, device-specific diagnostics. The amount and type of diagnostic information is determined by the manufacturer and varies with product and application. Diagnostic information can be accessed using the HART Communication Protocol. Host applications using DD files can interpret and display diagnostic information. Applications not using DD technology may require product-specific software modules to interpret diagnostic information.

Many manufacturers offer special software applications for their own products. Some modules allow users to customize for specific products. Manufacturers of valve actuators have made extensive use of this capability to provide preventative and predictive diagnostic information that greatly enhances the value of their products as compared to conventional actuators.

Several software applications are available that provide continuous communication with field devices using a HART-compatible multiplexer and HART I/O (see *Multiplexers*). These applications provide real-time monitoring of status and diagnostic information.

CONNECTING A PC TO A HART DEVICE OR NETWORK

Personal Computers are commonly used for HART host applications for configuration and data acquisition. A specially designed device (HART Modem) allows the HART network to be connected to the RS232C serial port or USB port of a PC (Fig 17).

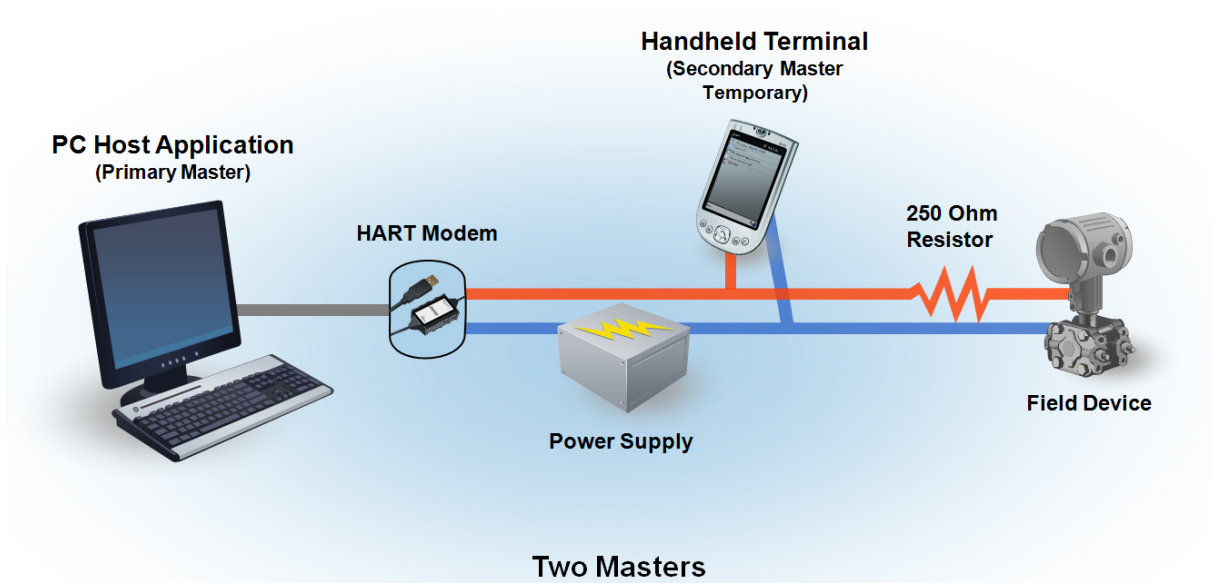





Figure 17 – PC- based Device Configuration Using a HART Modem

INDUSTRY APPLICATIONS

Many companies in a wide variety of industries have realized the advantages of using the HART Communication Protocol. In this section you can read real-world applications and the benefits that companies around the world have realized through the application of HART technology. In addition to three generic application examples (pages 60-62), information is provided from the following international companies:

INDUSTRY	COMPANY	LOCATION	PAGE #
Biopharmaceutical	Lonza	Switzerland	62
Bio-technologies	Genentech, Inc.	USA	65
Chemical 	Dupont	USA	70
	Eastman Chemical Co.	USA	76
	Monsanto	USA	78
	Sasol Solvents	South Africa	84
Communications	ORBCOMM Global	USA	91
Energy	BP Canada Energy	Canada	94
Food	French National Institute for Agronomic Research (INRA)	France	99
Glass	Cebrace	Brazil	102
Oil & Gas 	Midwest Gas Company	USA	106
	Pemex	Mexico	109
	PVDSA	Venezuela	112
	Shell	Nigeria	115
	Statoil	Norway	118
Pharmaceutical	Clariant	Germany	125
Plastics	BP Cooper River	USA	129
Power & Energy	National Grid	USA	133

INDUSTRY	COMPANY	LOCATION	PAGE #
	Ohio State University	USA	135
Pulp & Paper	Appleton Paper	USA	140
	Fraser Papers	Canada	143
	Vallviks Bruk	Sweden	146
Steel	COSIPA	Brazil	148
Water & Wastewater 	AECOM	Canada	151
	Detroit Water & Sewerage Department	USA	154
	Milwaukee Metropolitan Sewerage District	USA	164
	Saline Water Conversion Corporation	Saudi Arabia	166
	Sluvad Water Treatment Works	Wales	169

APPLICATION

HART MULTI-DROP NETWORK FOR TANK LEVEL AND INVENTORY MANAGEMENT

Accurate measurements for inventory management are essential in all industries. The HART Communication Protocol enables companies to make sure inventory management is as efficient, accurate and low cost as possible.

Tank level and inventory management is an ideal application for a HART multi-drop network (Fig 18). The HART network digital update rate of 2 PVs per second is sufficient for many tank-level applications. A multi-drop network provides significant installation savings by reducing the amount of wiring from the field to the control room as well as the number of I/O channels required. In addition, many inexpensive process-monitoring applications are commercially available to further lower costs.

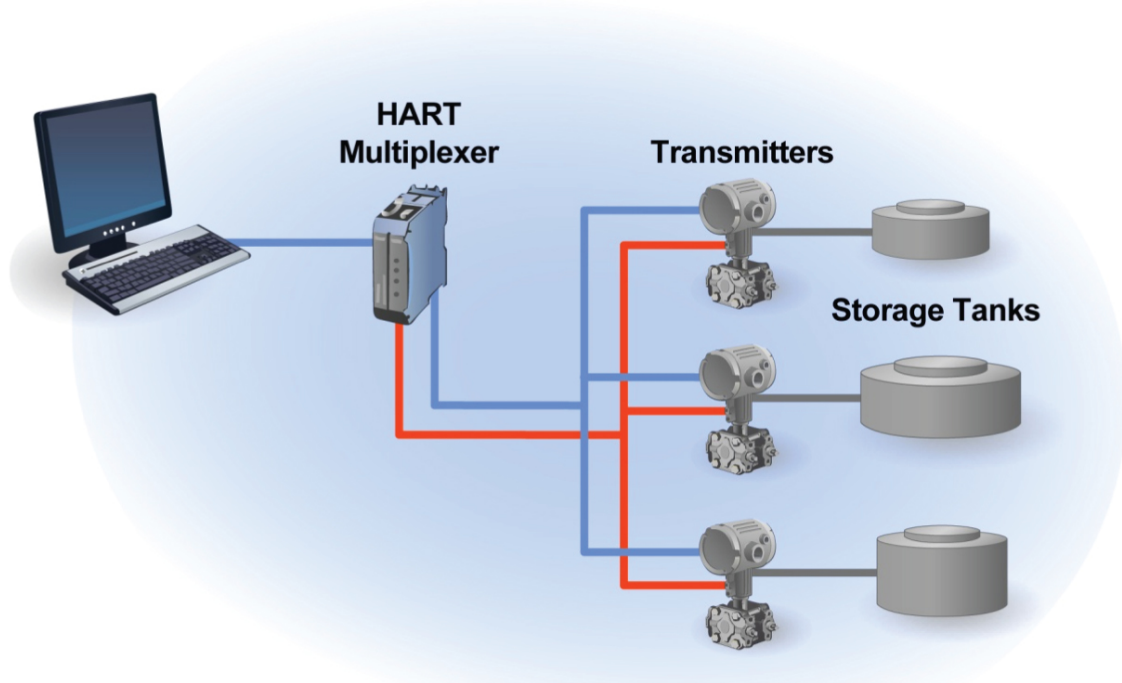

Figure 18 – Inventory Management with Multi-drop

One company uses a HART multiplexer to digitally scan field devices for level-measurement and status information. The information is forwarded to the host application using the Modbus communication standard. Multivariable instruments further reduce costs by providing multiple process measurements, such as level and temperature, which reduces the wiring and number of process penetrations required.

APPLICATION

MULTI-DROP FOR TANK FARM MONITORING

In one tank farm application, 84 settlement tanks and filter beds on a very large site (over 300,000 m²) are monitored using HART multi-drop networks and HART RTUs (see *SCADA/RTU Systems*). The HART architecture required just 8 cable runs for 84 tanks, with 10-11 devices per run (Fig 19). Over 70 individual runs of over 500m each were eliminated. Cable savings were estimated at over \$40,000 (USD) when compared to a conventional installation. RTU I/O was also reduced, which resulted in additional hardware and installation savings. The total installed cost was approximately 50% of a traditional 4-20mA installation.

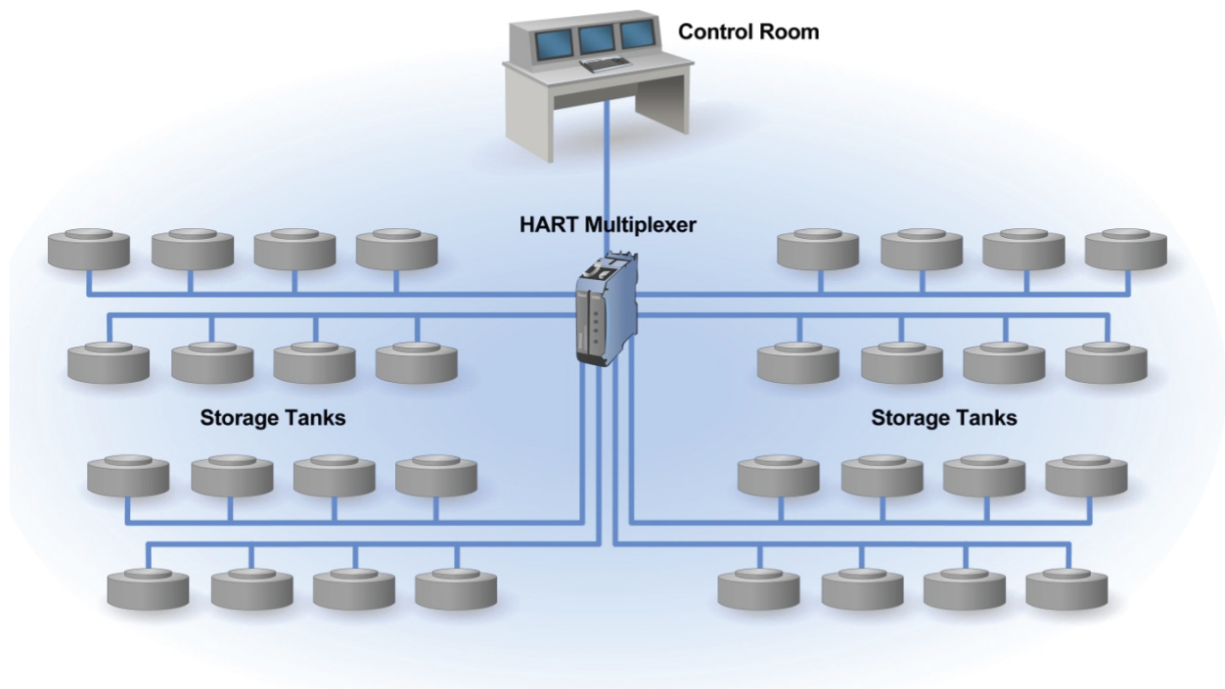

Figure 19 – Tank Farm Monitoring with Multi-drop

APPLICATION

UNDERGROUND PETROLEUM STORAGE USING HART FOR ACCURACY

Underground salt caverns are frequently used for crude oil storage. One customer pumps oil from barges into the storage caverns. An ultrasonic flowmeter records the total flow. To get the oil out of the caverns, a brine solution is pumped into the cavern through a magnetic flowmeter. Brine and crude oil flowing in both directions are measured and reported to the DCS using the HART Communication Protocol for accuracy. The DCS tracks flow rate and total quantity to maintain a certain pressure inside the caverns (Fig 20).

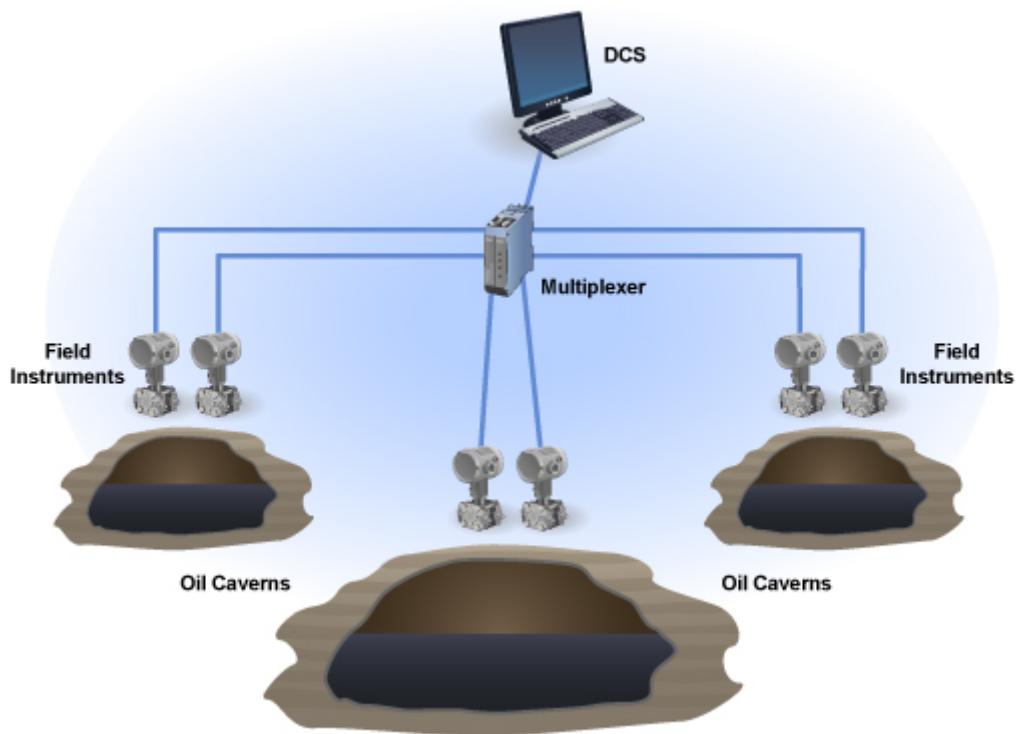

Figure 20 – Underground Petroleum Storage

LONZA CHOOSES HART TECHNOLOGY FOR QUICK VALIDATION AND COMMISSIONING



PROJECT OBJECTIVES

- Assure quality data communications in processing specialty pharmaceutical and biotech chemicals

SOLUTION

- Used for both distributed control and asset management system applications
- A batch system exclusively using HART-enabled instrumentation across 1,700 I/O points
- Another DCS system hosts 1,400 HART devices with 7000 I/O points

RESULTS

- HART Communication reduces field device commissioning time by half; 'pays for itself' through auto-generation of validation documentation
- HART technology supports continued adherence to current Good Manufacturing Practices

Lonza, headquartered in Basel, Switzerland, is one of the world's leading suppliers to the pharmaceutical, healthcare and life science industries. The chemical processor has a specialty in high-quality biotech products, which are manufactured at its largest processing and research and development facility in Visp, Switzerland. Among its challenges, the site, with 2,600 employees, must assure quality in the microbial fermentation of active, intermediate ingredients such as vitamin B3 or niacin, of which Lonza supplies roughly 75 percent of the world's demand.

Multi-product plants

To support current Good Manufacturing Practices (GMP) in its Small Scale Biotech Manufacturing facility (BPMSS) commissioned in 2004, Lonza chose HART technology for data communications between process instrumentation and the distributed control system (DCS), including the plant's first plant asset management system. This system, integrated with its process control system, spans more than 1,700 I/O for measuring temperature, pressure, flow, level and various analytical parameters.

HART Tech's Speed, Validation Documentation Justifies Cost

The BPMSS employs 67, in two areas, microbial fermentation in one building and a purification process housed in a new building. The facility, which uses solvents in fermentation and purification zones, is designed to hazardous-area standards.

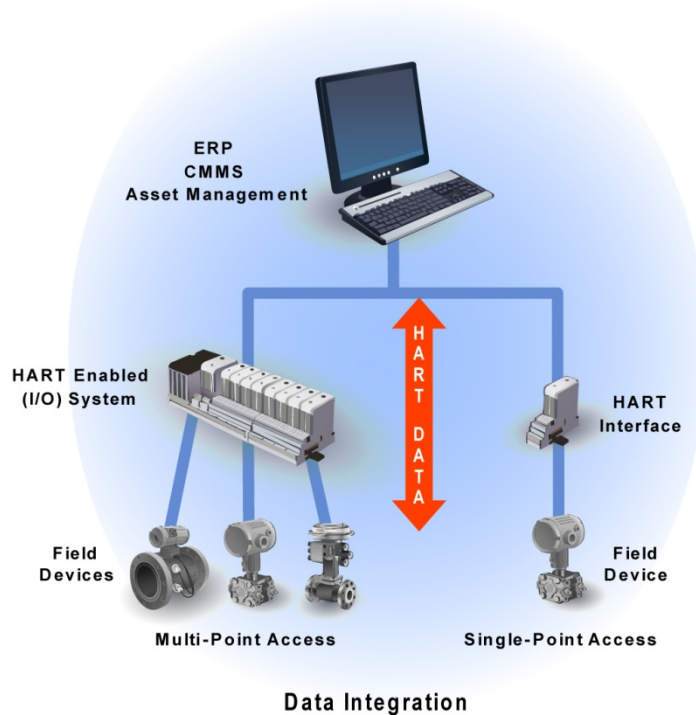

Together with the DCS and asset management system, HART Communication “offers many advantages in the BPMSS plant,” says Hermann Hutter, responsible for engineering and automation in the upstream Lonza Exclusive Synthesis portion of the process.

Here, a 1,000-liter fermenter runs recipes in batch cycles that typically last five to eight days. HUTTER says of HART technology’s benefits: “It speeds up the commissioning of the field devices; the device commissioning time is halved.” Additionally, he says the asset management system “pays for itself through the savings in the automatic creation of required validation documentation.”

HART technology is a standard off-the-shelf option from all the major instrumentation suppliers Lonza uses; the company uses only HART technology-equipped field devices.

New, Larger Plant Also Uses HART Technology

Following success in its batch operations, Lonza chose HART technology as a solution in a new, larger Biotech Pharmaceutical plant housing two 15,000-Liter fermentation units — that’s 30 times the production capacity of the BPMSS facility.

The new facility employs an estimated staff of 150 and boasts a considerable process automation network of more than 7000 I/O points and 1,400 HART-enabled field devices communicating across 55 DCS controllers, five servers, 30 operator stations and 60 human-machine interface stations.

Even as engineers were evaluating the extent to which it will use Foundation fieldbus, Hutter says, “we have again decided for the HART technology, because the low risk of installing, which guarantees an in-time plant start-up and offers a larger catalog of instruments.”



2005 HART Plant of the Year - FINALIST



GENENTECH USES HART TO REDUCE LIFE CYCLE DEVICE MANAGEMENT, INSTALLATION AND START-UP COSTS

PROJECT OBJECTIVES

- Reduce installation costs and startup risks during construction of new biotechnology facility
- Manage critical device configurations that have a direct impact on plant efficiency and product quality
- Reduce lifecycle device management costs

SOLUTION

- Integrate HART Communication with distributed control system (DCS)
- Install HART-enabled instrumentation and products throughout facility

RESULTS

- Mitigated risks
- Eliminated addressing, network-sizing, special communication requirements
- No learning curve
- Enhanced view of instruments
- Remote device setup and configuration
- Online configuration-management database
- Regulatory compliance protection

*Biotechnology manufacturer Genentech Inc. (San Francisco) is integrating HART Communication with the distributed control system (DCS) in its CCP2 facility in Vacaville, California, to manage critical device configurations that have a direct impact on plant efficiency and product quality. **Genentech** chose HART technology because of its cost-effectiveness, availability, reliability, ease-of-use and flexibility.*

“You can use HART to implement all the high-value functions of other bus technologies, but at a fraction of their cost, by using infrastructure that you probably already have in your plant today,” says Kevin Kerls, a senior automation engineer in Genentech’s automation group. Kerls is helping automate the Vacaville facility, which is currently under construction and is expected to produce 200,000 liters of oncology pharmaceuticals by 2009.

Biotech's Digital-Analog Future

Genentech is implementing HART technology with 15% of the I/O in the Vacaville facility. "There are a lot of instrumentation manufacturers that offer HART-compatible products. That availability plus a huge installed base makes HART a proven technology," says Kerls.

"This is technology that's going to continue to be supported and developed. It uses the same 4-20mA wiring you'd use in traditional I/O, so there's no steep learning curve." He emphasizes this means reduced installation costs and reduced risks during startup.

Kerls adds that the simultaneous analog and digital communication capability of the HART Protocol is a key attribute. "We're able to implement HART over simple 4-20mA twisted-pair signal cable, a proven and simple installation method," he says. "There are no addressing schemes, network-sizing concerns, or special communication requirements to deal with."

And because the protocol uses standard signal cabling methods, there's no learning curve for installers either, he adds. "Since HART is so widely used already, there's a very small learning curve for maintenance technicians."

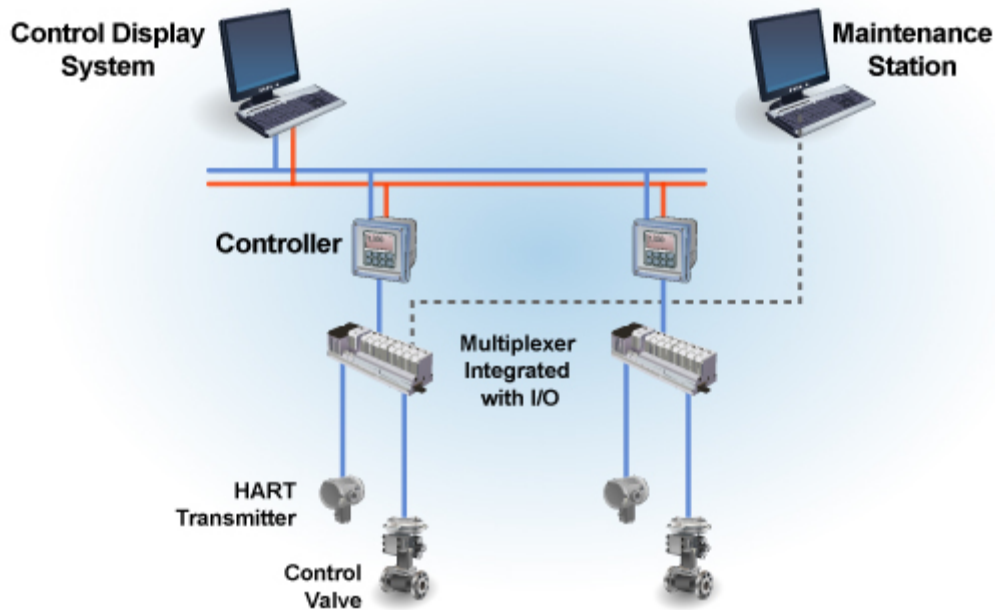

Genentech reports it also chose HART Communication because its installed instruments are HART-enabled. "So, we need no new infrastructure other than a new database server. The information is seamlessly integrated throughout the I/O, the DCS controller, and the process data server," Kerls says. In other systems, however, he believes multiplexers or other devices are needed to pick up digital signals. "With our system, HART data is tightly integrated so that information is available right in the DCS."

Kerls adds it's important that Genentech can use any vendor's flow or temperature devices as long as they're HART-compatible. "If a device that we wanted had a HART option, we asked for it. For almost all devices, the HART capability was free from the vendor. But even if the HART option cost money, we still purchased it," he recalls.

Remote Configuration Nearby

The ability to view instrument health and other monitoring parameters is available in Genentech's DCS without implementing added hardware.

"We're able to view/modify instrument configurations without interrupting process monitoring," Kerls explains. Genentech chose HART Communication because other buses had design issues, which are different from HART and its 4-20mA capability. "So it takes more time to get other buses operable. We really felt that we get the majority of the benefit via HART," he adds.

Number one on Kerls' list of HART benefits is an enhanced view of the instruments. "This includes status, alarming information, and remote configuration."

Genentech also values the remote capabilities of HART technology. "The biggest bang for the buck is remote configuration and remote monitoring. HART won out over all the other buses," Kerls asserts. "Because HART provides remote capabilities, installation simplicity, and met our requirements, it easily beat the other buses."

Remote device setup and configuration is essential because it allows Genentech to easily backup instrument configurations using a central database. The firm also can make changes to instrument configurations from a controlled database compliant with *21 CFR Part 11—Title 21 Code of U.S. Federal Regulations Part 11: Electronic Records; Electronic Signatures from the U.S. Food and Drug Administration*. Kerls says this was possible without relying on handheld devices or a technician's handwritten notes.

Overall Configuration Crucial

Central configuration management is another area where Genentech will use the HART protocol in their new facility. The company will use a database to capture, view, verify, test, and backup instrument configurations for more than 1,125 instruments during the startup of CCP2.

"The HART protocol with its online configuration-management database eliminates the need for a time-consuming paper process," says Kerls. "It probably saves an hour off each calibration which basically is a half a person-year saved under normal operations. In initial documentation of parameters and startup, this may also save 3,000 hours. These are very conservative estimates."

Compared to traditional I/O, Genentech can use HART Communication to diagnose an instrument just by opening a view, rather than sending someone out to the device's location. "If anything goes wrong with that device, it'll notify the operator through a DCS alarm," he adds.

Genentech reports that HART-associated work at CCP2 is enabling more efficient management of instrument configuration. “Once we get this up and running, part of corporate automation engineering’s role is to disseminate information about the project throughout the corporation,” says Kerls “This also means educating our maintenance group on our systems’ capabilities and developing efficient processes to leverage HART-enabled technology.”

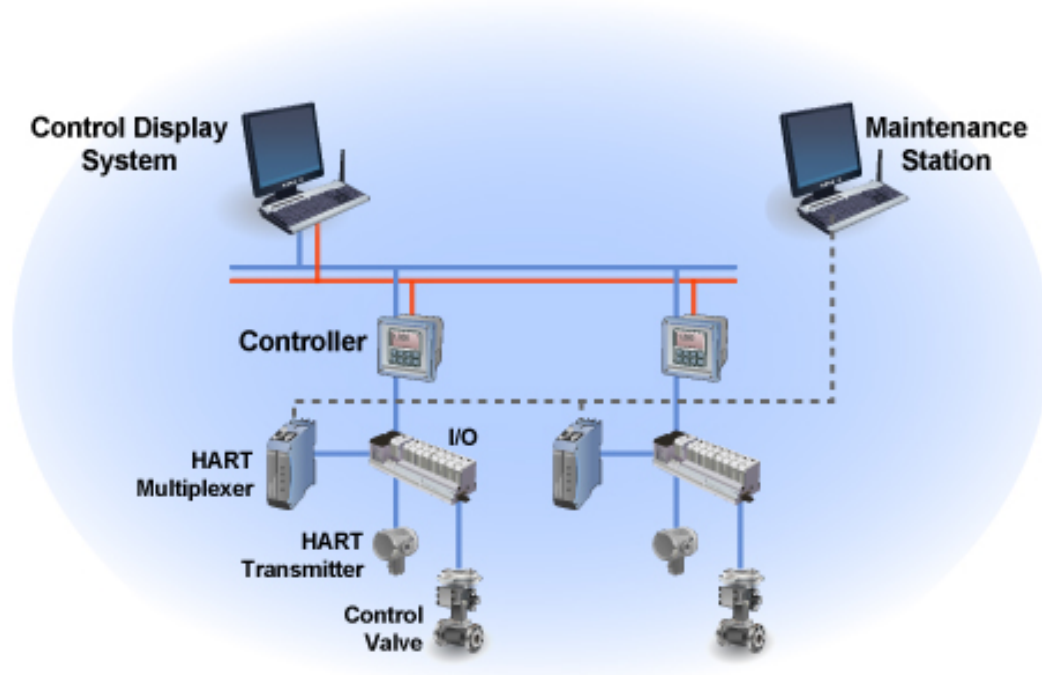

Another benefit provided by HART technology at this facility includes building the corporation’s instrument configuration-and-calibration Standard Operating Procedures (SOP) on how to use the protocol and Genentech’s configuration management database.

“We’ll continue to minimize the time required to perform configurations and calibrations,” Kerls emphasizes. “You can put these technologies in, but if you aren’t educating your lifecycle group—maintenance and the local automation engineering group—to use them, then the corporation never gets the full benefit.”

Benefits may be limited by not partnering with maintenance and local automation engineering on the front and back ends of a project. “You may provide a solution based on incorrect assumptions and it may not meet their business criteria,” says Kerls. “And, if you don’t partner with them on the back end of the project, the SOPs won’t be developed with HART technology in mind.”

Compliance Protects Doses

Diagnostics. Maintenance. Regulatory compliance. SOPs exist for them. All are taken seriously at CCP2, and HART technology plays a crucial role here, too.

“Our HART devices are installed as part of an 8,500-I/O DCS. Any device errors or alarms will automatically be available to the operators/technicians,” explains Kerls. HART Communication allows Genentech’s staff to receive device-specific alarm values, which reduces troubleshooting time. Faster problem identification goes directly to the bottom line.

In addition, the HART Protocol helps CCP2’s service department minimize the time required for troubleshooting and calibrations. This is because all configuration parameters historically were noted by hand and often were misplaced, lost, or simply incorrect, Kerls adds. “Our HART implementation will ensure that the current configuration is always correctly backed up.”

And, if an instrument needs replacement, HART also simplifies this process. “We simply need to download the backed up configuration for the old instrument from our HART configuration management database. These configuration parameters then upload to the new device directly through the analog I/O card without special connections,” says Kerls. “Being able to effectively manage our instrument configurations reduces our regulatory risk and our risk to product.”

Risk to product involves reduced efficiency, which usually means producing less and producing poorer quality. “If a critical instrument is involved and you can’t prove you had adequate control over properly configured devices, it could lead to regulatory action and/or a recall of the entire batch,” says Kerls. “More than likely, however, you’d have offline analytical measurements to monitor the batch so you might not lose the batch, but you might spend a lot of time defending it.”

Overall, Kerls is even more optimistic about the role of HART technology in Genentech’s future. “If HART works well at CCP2, we can just roll it out to other Genentech plants,” he says. “If you use HART, you’re going to save big time in lifecycle device management because the installation cost is no more than if we installed traditional I/O systems.”



DUPONT USES HART DATA TO SATISFY SAFETY INTERLOCK SYSTEM VALVE TEST REQUIREMENTS

PROJECT OBJECTIVES

- Needed a better way to test safety interlock control valves during plant operations.

SOLUTION

- DuPont added intermediate instrumentation to extract relevant data from the plant's HART instruments, and Moore Industries' SPA HART loop monitor and alarm is used for this purpose
- Use partial valve-stroke testing of emergency shutdown valves during normal operations for fewer and shorter shutdowns.
- HART data is superimposed on the 4-20mA connection, and the SPA loop monitor and alarm extracts the valve-stem position from the HART data. The SPA then sends the actual valve-stem position data to the DCS via an additional 4-20mA connection.
- Over 100 control valves equipped with Moore SPA loop monitors were installed, so valve safety interlock testing would be a less labor-intensive and cumbersome operation

RESULTS

- Expedites testing of safety interlock valves, shortening plant shutdowns
- Provides fail-safe inputs to the hard-wired relay safety interlock system
- Allows remote configuration and ranging of virtually all instrumentation
- Reduces number / duration of shutdowns by using partial valve-stroke testing
- Establishes the foundation for an asset management system

"Virtually all of the plant instrumentation is HART-enabled...temperature, pressure, level, and flow."

The **DuPont** DeLisle titanium dioxide manufacturing facility in Pass Christian, Mississippi, uses HART Communication full-time in daily operations even though it does not have a HART-enabled control system. The plant is migrating to using HART data for additional cost-effective solutions that will deliver significant benefits to the enterprise today and into the future.



The DeLisle plant produces DuPont's proprietary R-104 Ti-Pure titanium dioxide (TiO₂). TiO₂ is a white pigment used in paint, plastics, and products where color retention is desired. TiO₂ absorbs ultra-violet light energy and it also possesses light-scattering properties that enhance whiteness, brightness, and opacity.

TiO₂ production requires a sophisticated manufacturing process that includes chemical reduction, purification, precipitation, washing, and chlorination of titanium, iron, and other metal sulfates.

"DuPont determined that the best way to control and monitor these processes was with HART-enabled instrumentation," says Joe Moffett, project manager with DuPont. "Virtually all of the plant instrumentation is HART-enabled, and this includes instruments used to monitor and control temperature, pressure, level, and flow."

The DeLisle plant control and instrumentation system uses the HART Communication Protocol in a variety of ways. HART data is used as an input to the safety interlock system and as an input to the control system. Like most other users, DeLisle personnel use handheld HART communicators for configuration, calibration, and troubleshooting. And as we'll see, future plans call for HART data as a key input to an asset management system.

Normal plant operations are controlled by a Honeywell TDC-3000 distributed control system (DCS), and the DCS is also used with a hard-wired relay system to control safety shutdown systems. Although future generations of Honeywell DCSs will be able to directly receive and transmit HART data, the present DCS does not have HART communications capability.

DuPont needed to add intermediate instrumentation to extract relevant data from the plant's HART instruments, and Moore Industries' SPA HART loop monitor and alarm is used for this purpose.

One of the main reasons DuPont selected the SPA instrument is that Moore Industries submitted the SPA to an independent third party for failure modes, affects and diagnostic analysis (FMEDA).

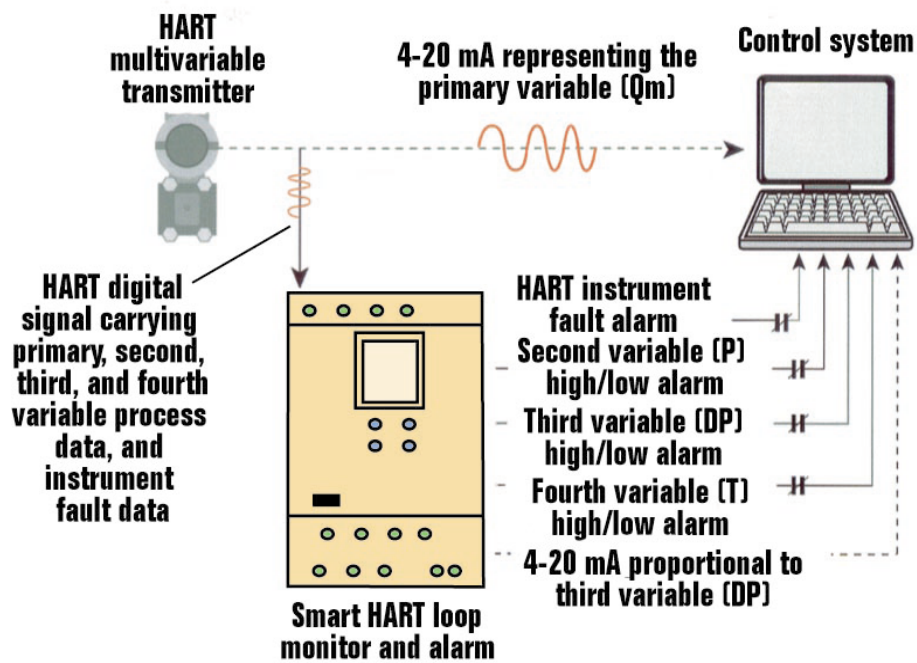

"FMEDA is a detailed circuit and performance evaluation that estimates the failure rates, failure modes, and diagnostic capabilities of a device," explains Bud Adler, director of business development with Moore Industries. "Using the reliability data from the SPA's FMEDA report, DuPont is able to verify that required safety integrity levels (SILs) are attained."

HART Increases Uptime

TiO₂ production involves many critical and potentially hazardous processes, so reliable operation of the safety shutdown systems is of paramount concern. DuPont uses HART to provide key safety interlock inputs to the DCS and to the hard-wired relay system.

The safety interlock system has a number of on/off control valves, each equipped with a HART-enabled valve-stem positioner. Each control valve is connected to the DCS via a 4-20mA signal sent from the DCS to control the valve position. HART data is superimposed on the 4-20mA connection, and the SPA loop monitor and alarm extracts the valve-stem position from the HART data. The SPA then sends the actual valve-stem position data to the DCS via an additional 4-20mA connection.

CRITICAL INTERLOCK DESIGN - OVERVIEW

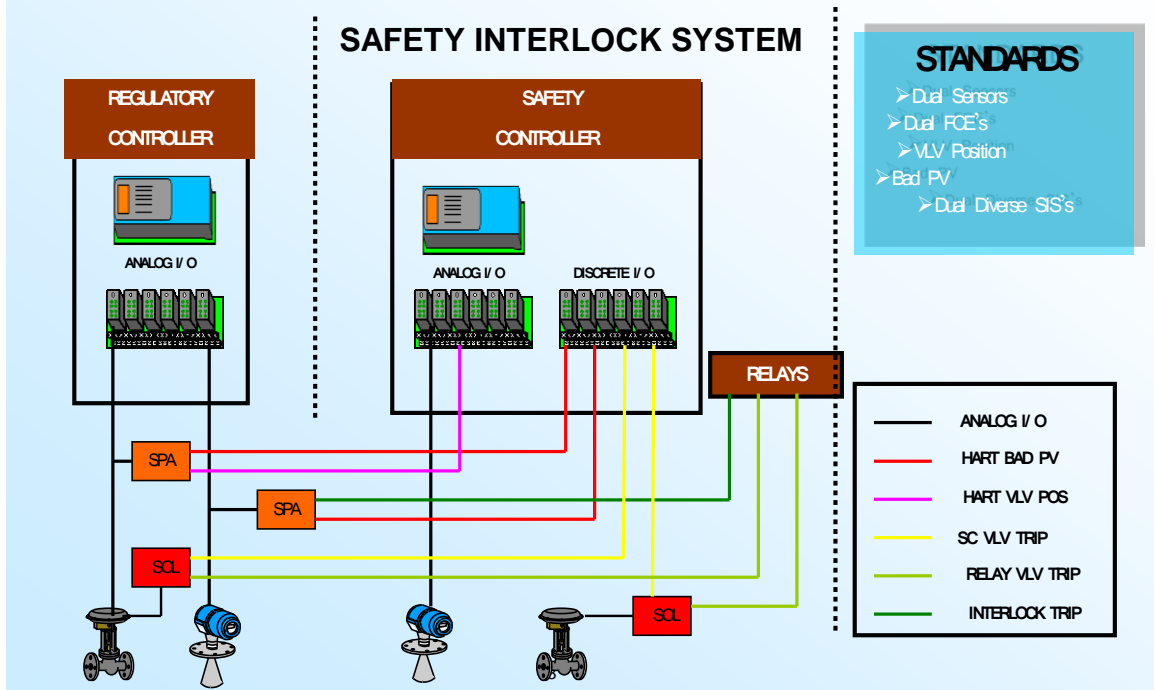

The DCS compares the valve control output signal to the HART valve-stem position data to ensure proper positioning. This data is used to verify correct functioning of the valve in normal operations, and to test the valve when DuPont performs periodically required plant shutdowns to verify operation of the safety shutdown system.

The HART data allows DuPont to test valve safety interlock operation from the control room. Control room operators place the appropriate DCS output in manual mode and adjust the 4-20mA control valve output signal to open and close the valve. The SPA sends a 4-20mA signal derived from the HART data back to the DCS to verify valve position.

Consider the alternative: If the valve-stem position data was not available at the DCS through HART and the SPA, DuPont would have to station an instrument technician at each valve to observe valve operation. The technician would have to observe valve travel, and communicate this information to control room personnel.

"There are over 100 control valves equipped with Moore SPA loop monitors, so valve safety interlock testing would be a labor-intensive and cumbersome operation without HART Communication," observes Moffett.

Online Tests Reduce Outages

DuPont has plans to take valve testing to another level—a level that will reduce the number and lengths of outages required for safety interlock testing. Certain valve testing requirements for safety interlock systems can be met with partial valve-stroke testing of emergency shutdown valves during normal operations. Performing those tests during normal operations means fewer shutdowns are required, and the required tests take less time so the shutdowns can be shorter.

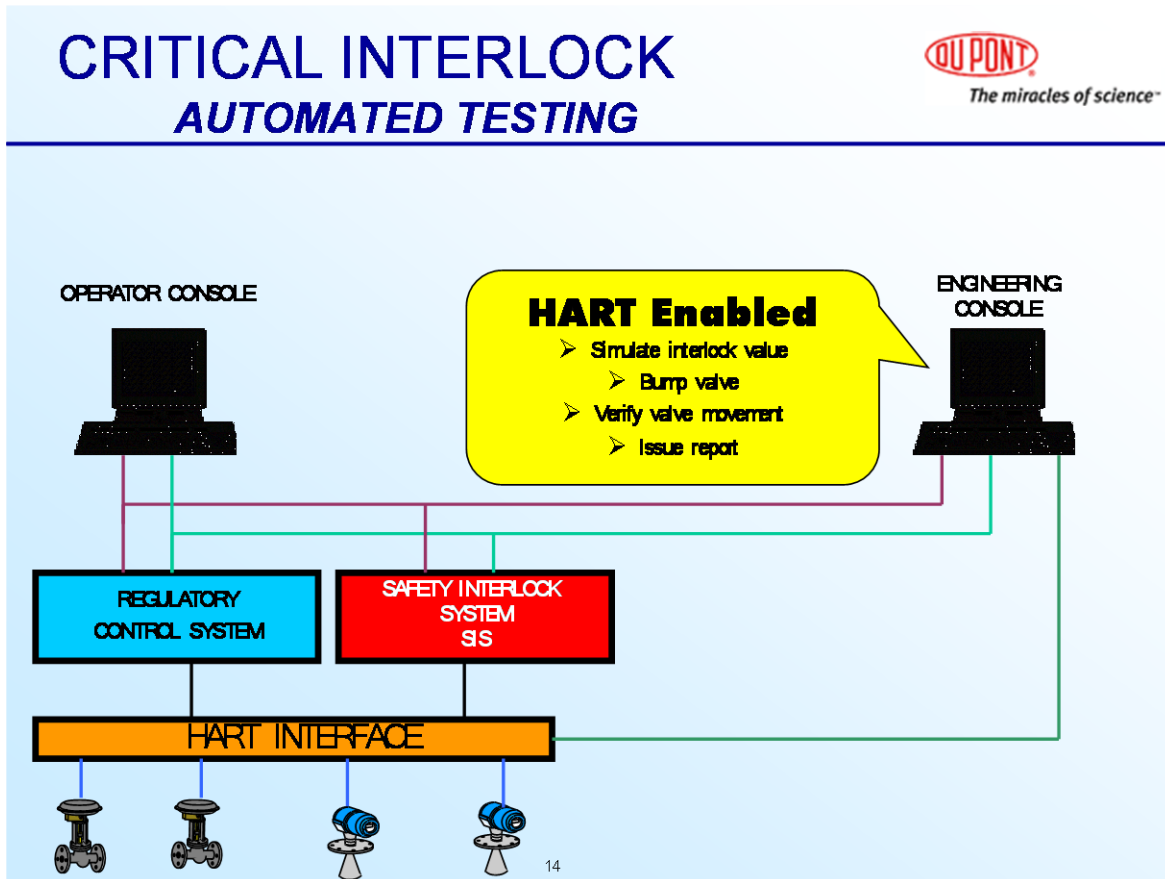

Partial valve-stroke testing during normal operations is a procedure, either manual or automated, used to stroke a valve over a small percentage of the valve's total travel range. For example, a safety interlock valve might be fully closed during normal operations. Partial valve-stroke testing could be used to move the valve to a slightly open position. This would verify valve operation without affecting normal operations.

The present system could be used to undertake manual partial valve-stroke testing, or an upgraded system could be used to implement automated partial valve-stroke testing.

"We are currently evaluating device management system that would be able to directly accept data from all of our HART instruments," Moffett says, "and the system could be used to implement automated partial valve-stroke testing."

Other plans call for using additional SPA capabilities to monitor the diagnostic status of the valve-stem positioners, to provide alarm on low valve-operating air pressure, and to provide relay contacts for open and closed valve position. For more critical applications, one-out-of-two (1oo2) and two-out-of-three (2oo3) configurations can be used to increase availability and reliability.

Fail-Safe System Relies on HART Communication

Most safety interlocking at the DeLisle plant is implemented through a dedicated DCS controller, but certain processes must be equipped with a hard-wired relay safety shutdown system. Many of these processes use HART-enabled pressure and temperature transmitters. Each of these transmitters sends a 4-20mA process variable signal to a Moore Industries SPA loop monitor that decodes the HART data superimposed on the 4-20mA signal.

The SPA then sends a process variable signal derived from the HART data to the DCS, and it also sends fail-safe alarm contacts to the hard-wired relay safety shutdown system. These alarm contacts are set to indicate high-level, low-level, and the presence or absence of the HART signal.

HART-enabled instruments allow DuPont to operate the plant in a safe and efficient manner. "HART and the SPAs provide a solution that unlocks a wealth of diagnostic and process information in the positioners and transmitters," says DuPont project manager Joe Moffett. "This information is used to increase reliability and minimize the duration of required plant shutdowns."

DuPont is using this highly efficient TiO₂ processing site as a benchmark for other facilities because of its outstanding compliance with safety, health, and environmental requirements. DuPont plans to fully exploit the available HART data with an asset management system that will provide automated partial valve-stroke testing, predictive maintenance alerts, and comprehensive management of the plant instrumentation system.

Major Benefits of HART Communication for DuPont

- Expedites testing of safety interlock valves, shortening plant shutdowns
- Provides fail-safe inputs to the hard-wired relay safety interlock system
- Allows remote configuration and ranging of virtually all instrumentation
- Reduces number / duration of shutdowns by using partial valve-stroke testing
- Establishes the foundation for an asset management system



2002 HART Plant of the Year



EASTMAN CHEMICAL USES HART PRESSURE TRANSMITTER TO ACHIEVE COST-EFFECTIVE MAINTENANCE

PROJECT OBJECTIVES

- During process upsets, tank pressure exceeded range of analog pressure transmitters

SOLUTION

- Installation of a single HART-enabled transmitter, replacing two analog transmitters

RESULTS

- HART Communication lets the transmitter read actual voltage to determine actual pressure without re-spanning the transmitter and introducing error
- Upsets that exceed expected range can be accurately measured by the digital HART Communication signal.
- Remote configuration saves time by reducing trips to the field

One HART-enabled transmitter replaces two analog transmitters to cope with pressure spikes and offer more cost-effective maintenance

At Eastman Chemical Co.'s operation in Longview, Tex., pressurized tanks may have an allowable working pressure of 63 psig, which may be 10 times more than the span of the tanks' pressure transmitters. According to Josh Lowery, electrical engineer at Eastman Chemical, pressure variations in those tanks can cause problems.

On startup, one tank's pressure shot up and popped a relief valve. "The tank shot up past 12 psig," says Lowery, who adds that the tank's pressure transmitter span is 0-12 psig. A solution using HART technology includes only one transmitter, rather than two as required before.

We use the HART signal to read the actual value at the cell, and so read the full range of the transmitter," says Lowery. This means operators can determine the actual pressure without re-spanning the transmitter, which can increase transmitter error tenfold. "We can strip the HART signal, and get full

range from transmitters in which the scale has decreased,” he says. “When we have upsets where the process went out of the expected range, we can capture the actual reading from the HART signal.”

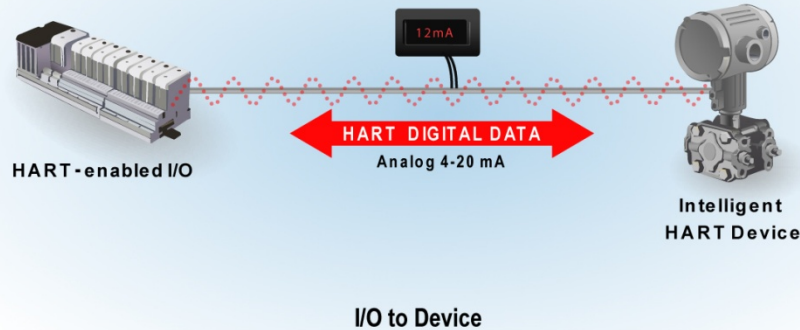

Fewer instruments, a HART-enabled device, and improved diagnostics help Eastman Chemical save on equipment cost and maintenance time.

In addition, HART technology’s remote configuration capability has helped improve operations at the Texas facility. “HART saves us the time we used to spend going to and from the instrument,” Lowery says. “More importantly, hazardous-area work requires many more permits. Hooking up with HART in the control room is much easier.”

Remote configuration also allows Eastman to verify field wiring from the control room. Fewer instruments, a HART-enabled device, and improved diagnostics means Eastman saves on equipment and maintenance.

MONSANTO USES HART TO OPTIMIZE ASSET RELIABILITY AND IMPROVE PRODUCTIVITY

PROJECT OBJECTIVES

- An engineer responsible for managing communication and control systems across two new chemical plants with a combined 10,000 I/O points, sought a communication solution with the intelligence to predict failures
- Expand opportunities to take advantage of a new smart I/O infrastructure to incorporate data using the HART Protocol.
- Identify instrumentation issues before they impact production for better planning of scheduled, predictive maintenance repairs.

SOLUTION

- Implemented Asset Criticality review and assigned ratings to more than 14,000 pieces of equipment and instrumentation plant wide, including transmitters, control valves, and vapor sensors.
- Used the 700 installed HART-enabled devices and smart valve positioners to take advantage of both handheld and remote office-based systems.
- Analyzed their data to quantify predictive versus reactive work by generating a “bad actor” list that shows how much “cost avoidance” the reliability program is providing.
- Integrated intelligent HART device information with plant control, CMMS (SAP), asset management and maintenance systems...and users.

RESULTS

- By getting connected to the information in their HART devices, improved instrument reliability and reduced reactive maintenance costs
- Deployed predictive and condition-based techniques for early detection of instrumentation issues (plugging, fouling, etc.) and prevented incidents costing \$100,000 per hour of downtime.
- Eliminated incidents of expedited products and environmental and safety problems that can result when work is rushed during unplanned outages.

- Reduced the number of nuisance alarms and the ability to “turn off” tracking for some previously tracked data.
- Identified “bad actor” devices through reliability efforts saving the plant \$800,000 to \$1.6 million per year in cost avoidance.

For the past few years, Monsanto’s Muscatine, Iowa, manufacturing facility has undergone a transformation in communication, in part through utilizing the capabilities of HART Communication in order to enhance reliability data and help the plant achieve a new level of productivity. Using the intelligent device information significantly reduced costs and improved plant operations enabling the transition from reactive to proactive and predictive maintenance.

The Muscatine facility spans 150 acres and employs more than 450 people to operate and manage eight process units running 24/7, year round, to produce agricultural chemical products including Roundup



herbicide and Acetanilide Select Chemistry products such as Harness Xtra, Degree Xtra, and Warrant herbicides. Starting in 1997, the installation of HART Communication-compliant devices has helped enable the plant to switch from batch to continuous operation across processing units as well as in its Waste Treatment and Utility process and Formulations and Packaging process.

Operating since 1961, the plant has undergone various changes and expansions, resulting in a variety of automation systems. Ongoing efforts

have helped to integrate systems site wide, including an SAP computerized maintenance management system (CMMS) and Emerson’s AMS asset management system.

This is a distributed platform that includes a central server, which hosts a master database and interfaces with three DeltaV distributed control systems (DCSs) and four legacy Provox DCSs. Additional applications are also installed including: ValveLink software to manage control valves, AlertTrack for pushing critical device alerts to plant personnel; AMS Wireless for interfacing with a *WirelessHART* Protocol-based network; and Connector software for pushing/pulling information between the database and the calibration database. These systems and applications manage control networks site-wide.

In turn, control networks connect to more than 600 HART-enabled devices with more than 3,200 instrument assets total.

Setting asset priorities

"Asset Prioritization is the foundation of all our Reliability Programs," says Joel Holmes, site reliability engineer. That prioritization consists of continual evaluation and ranking of equipment according to several criteria that, in turn, determine the level of criticality for individual plant assets.

Initial efforts to prioritize assets included the reliability team's 2006 discovery of a dramatic 30% error in its SAP CMMS system, which lacked the ability to track reliability work such as labor and material costs to the level of specific assets. In keeping with the plant's Lean Sigma initiative, the plant reduced that error to below 5% by instituting order codes and deficiency notifications. This translated into more than 5,000 SAP records corrected.



By 2008, the plant's use of predictive maintenance (PdM) included various conditioned-based monitoring technologies--vibration, infrared thermography, motor analysis/testing, lubrication/greasing and ultrasonic analysis. These paid-off in one case with the detection of early signs of plugging in two mass flowmeters; back-flushing prevented up to six hours of downtime for a savings of \$100,000 per hour.

"By implementing conditioned based monitoring techniques, we can effectively identify, diagnose, troubleshoot, and ultimately repair issues prior to their effects negatively impacting production," Holmes says.

Hooking-up with HART technology

Since 2008, the plant has instituted a new level of reliability optimization to help prioritize, plan and schedule maintenance downtime for ongoing PdM, PM and control valve maintenance programs. This began with the Asset Criticality reviews in which the reliability team assigned ratings to more than 14,000 pieces of equipment and instrumentation plant wide, including transmitters, control valves, and vapor sensors. Each asset was evaluated and assigned an A, B or C ranking, most critical devices getting an “A” ranking, while others--such as run-to-fail assets or those with inline spares--being assigned a “C.”

The installation of the asset management system made it possible for the plant to use smart I/O communication with digital fieldbuses as well as, for the first time, the digital portion of the HART Communication signal. Today, the system encompasses approximately 700 HART-enabled devices and smart valve positioners.

There are two phases to the program, representing two levels of use of HART Communication:

- Phase I employs evaluations in the field using a handheld communicator or mobile computer to capture diagnostic data to an Excel-based file and, in turn, the CMMS, along with any deficiency notifications. This allows technicians to effectively identify, plan, schedule, and kit the needed parts and execute PM/PdM tasks.
- Phase II takes fuller advantage of HART Protocol and compliant software (i.e., ValveLink for Fisher and Trovis-View for Samson valve positioners) to remotely capture and compare diagnostic test results with historical data to determine any instance of degraded performance.

From hand-held to *Wireless*HART

Before the asset management system was in place, HART Communication was not used at the plant other than for device configuration. Today, the protocol is used in the field as well as in the asset management system, which Holmes says serves as “a smart handheld on steroids.”

Of course, it’s that and more. The asset management system supports a full, digital I/O infrastructure as well as HART-enabled I/O, however, older legacy systems don’t fully support this infrastructure. In such cases, handheld communicators allow personnel to perform diagnostics and testing. Monsanto is continuing to deploy HART technology in a way that will soon bring such data into seamless integration with all-digital fieldbus data using *Wireless*HART technology. This allows standard-compliant modems or adapters to send/receive data between HART-enabled devices and the control/automation system.

Where this has been deployed, data from devices communicating via *Wireless*HART and other protocols are seamlessly integrated into the asset management system for a fuller presentation of diagnostic information.

*Wireless*HART was first installed at the site's waste water facility. This was followed by a gateway

adapter at one of the site's Acetanilide herbicide manufacturing units, which include wireless data on six level instruments for pump seal pots. Five additional *WirelessHART* gateways have been purchased for installation in the near future. Plans call for *WirelessHART* network coverage to extend across the entire facility.

ROI paves way for plant wide expansion

As a result of the program's demonstrated ROI, reliability programs have been steadily migrated across the entire facility, providing increased availability, improved reliability, reduced downtime, and a reduction in reactive work.

The benefits range from small improvements, such as a reduction in the number of nuisance alarms and the turning off of previously required data flows to quantified dollar sums that are fueling expansion of the project.



For instance, code analysis data in the asset management system helps to quantify predictive vs. reactive work which in turn generates a Top Ten "Bad Actor" list with dollar figures on cost avoidance. This helps quantify the level of cost avoidance the reliability programs have been providing...and has helped leverage the program's expansion plant-wide. Averages of 12 deficiency orders are entered each month with a cost avoidance of over \$1600 per work order. This correlates to more than \$200,000 (USD) annually since 2008.

“By increasing our focus on Asset Reliability, we’ve made a positive step change in key focus areas, not to mention ROI,” Holmes adds, calculating that since 2008, when the reliability program began, the plant has achieved between \$800,000 and \$1.6 million in cost avoidance per year.

The key reason for these massive savings: connecting HART Communication and other protocol instruments to the asset management system providing a direct dynamic tie to the health of their instruments. This, in turn, has helped eliminate instances of expedited products, worker stress and mistakes during outages and the environmental and safety problems that can ensue from technical teams operating in a panic situation.

“HART-enabled devices (measurement devices and smart valve positioners) are at the core of this achievement. Now management is asking the reliability group to identify what we want to do next.” Holmes says.



2012 HART Plant of the Year

SASOL SOLVENTS USES HART TO IMPROVE ASSET MANAGEMENT

PROJECT OBJECTIVES

- An engineer responsible for managing communication and control systems across two new chemical plants with a combined 10,000 I/O points, sought a communication solution with the intelligence to predict failures

SOLUTION

- Communication was implemented using the HART Protocol in field instruments and a DCS from a preferred vendor
- HART technology facilitated a consolidation of hardware and software vendors, and a program to streamline and reduce maintenance-related alarms by 90%
- In one area of the site (acrylic acid and acrylates), 4,000 HART-enabled devices were used for a seamless diagnostic view for maintenance operations

RESULTS

- The new system provides yearly savings estimated at a conservative 6.5 million South African Rand, roughly \$1 million at the time of implementation
- HART device-based diagnostic capabilities led to removal of 40 of 350 non-essential control valves for savings of over a million
- Detection of faulty or poorly optimized valve positioners likewise led to savings estimated to top two million Rand

The HART Protocol was a natural choice because it was compatible with Sasol Solvent's existing relationships and installed control system technology

Handed the task of overseeing the implementation of communication and control systems that would serve as the automation data lifeline for two new plants, Sasol Solvents engineers started small, but finished big. The plants, to be constructed by South Africa's Sasol Solvents and Olefins and Surfactants, housed some 10,000 I/O points. A major installation of HART-capable intelligent devices led to big savings by using HART technology already in the company's chemical plants.



Johan Claassen, engineering manager for control systems, instrumentation, and electrical, began with a vision to implement a control system and corresponding field instrumentation that had the intelligence to predict failures before downtime resulted. This initial vision ultimately led to estimated yearly savings of 6.5 million South African Rand (US \$1 million).

"We significantly exceeded my expectations. I was expecting two or three million Rand in savings," he says. However, Claassen believes this figure to be conservative, as a number of benefits are hard or impossible to quantify.

Claassen's and Sasol's results benchmark what's achievable, according to Ron Helson, Executive Director of the HART Communication Foundation. "They really stepped out of the box and set the example for what is possible when you start using the full potential of smart instrumentation," he says.

To finish this big, however, Claassen faced numerous obstacles that had him battling balky technology and overcoming objections from sometimes skeptical management.

Breaking new ground

In 2000, Claassen dusted off his crystal ball and peered into the future. He didn't do this because of the new millennium. Rather, he went into the forecasting business because Sasol, an integrated oil-and-gas company with substantial chemical interests, needed to expand.

In response to that need, Sasol would, over the next few years, build a butanol plant capable of producing 150,000 metric tons a year of solvent for the company's customers in the paint and ink industries. The company would also construct an acrylic acid and acrylates project that would eventually supply about 125,000 tons of products. Because of these projects, two plants would arise from empty fields near the company's complex in Sasolburg, a town midway between Cape Town and Johannesburg, where Sasol had gotten its start 50 years earlier.

Claassen, who'd joined the company in 1995 with a control-system engineering degree from the University of Pretoria, focused on the automation and control systems proposed for the new facilities. He had his own plans for these systems, although he didn't have much of a team to help him push his ideas.

"The team consisted of two people—myself and a Sasol technology engineer—with the vision to implement a control system and field instrumentation that had the intelligence to predict failures before they caused plant downtime," he recalls. The group started looking for solutions, investigating various technology options. It also looked at different distributed control systems (DCS) to provide needed functions.

But Claassen could not start from a blank slate. The automation and control systems for the new plants had to take into account Sasol's existing relationships and installed technology. On that basis, HART-based instruments and HART I/O had an advantage. Sasol already had a limited installation of HART instruments and systems in other sites within Sasol's Solvents group. In addition, Claassen notes that the communications protocol offered another benefit.

"HART had the advantages of normal 4-20mA where you have one pair of wires per field device. Sasol's design specifications for the new plants were built around this," he says.

Finding success

Changing to another industrial communication protocol would have forced the company to update design specifications before building new facilities. But Claassen was prepared to go down that road because he felt that new technologies had to be part of the new facilities.

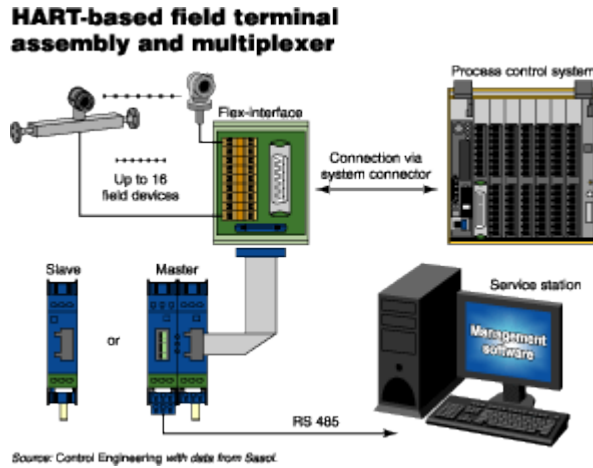

Others weren't quite as sure. The group's proposal for a control system involving HART, Foundation

Fieldbus, and a new DCS was brought before Sasol's board of directors in 2001, but that approach was rejected. Disappointed, Claassen and his team continued planning. "We had to make the best of the situation. Some of the board's arguments made sense, and we had to honor it," he says.

Several of those arguments involved timing and risk. The board approved a \$200 million butanol project in mid-2001 and fast tracked it for completion by the end of 2002. This approach, which involved taking on two new technologies—one for the DCS and the other for the communication protocol—seemed too difficult and presented too high a chance for failure.

Claassen's team reworked their ideas, concentrating on implementing HART along with a DCS from a vendor that Sasol had worked with before this project. When this idea was presented to the board, Claassen got approval for the combination.

A wrinkle at the time was that this particular vendor offered no integrated HART I/O solution, meaning that Sasol wouldn't be able to make use of the diagnostic capabilities of the technology. So the group decided to implement device management software from a rival vendor, using multiplexers to strip off the diagnostic information from the field devices. This solution required the use of OPC for communication and the development of a diagnostic bit-extraction tool to handle traffic between the hardware and software.

Disarming alarms

By the time the butanol plant was up and running in 2003, Claassen was hopeful that he had the desired automation and communication solution in place. Over time, though, his optimism faded. Part of the communication set-up in the plant involved signals being sent to indicate the existence of diagnostic errors in an instrument. An operator would then receive an alarm alerting him to the problem.

Unfortunately, operators and engineers were getting 10 alerts a minute, and many weren't about anything an operator could affect. Consequently, those alarms were largely ignored.

Due to this alarm situation, the Sasol team switched its approach in 2004, implementing a solution that used the same vendor for both hardware and software. The company also embarked on an alarm management program and changed its philosophy on maintenance-related alarms, meaning that operators were only presented with those alarms they could do something about. Claassen reports that, today, the number of alarms seen by operators has been cut by more than a factor of 10, and that's only the beginning of the upgrades.

"As things improve, we will start training the operators to do first-line fault finding on our asset management software as well," he says.

The change in alarm philosophy coincided with the completion of the acrylic acid and acrylates facility and completion of current building projects. At present, Sasol uses some 4,000 HART instruments and about 400 FOUNDATION fieldbus devices.

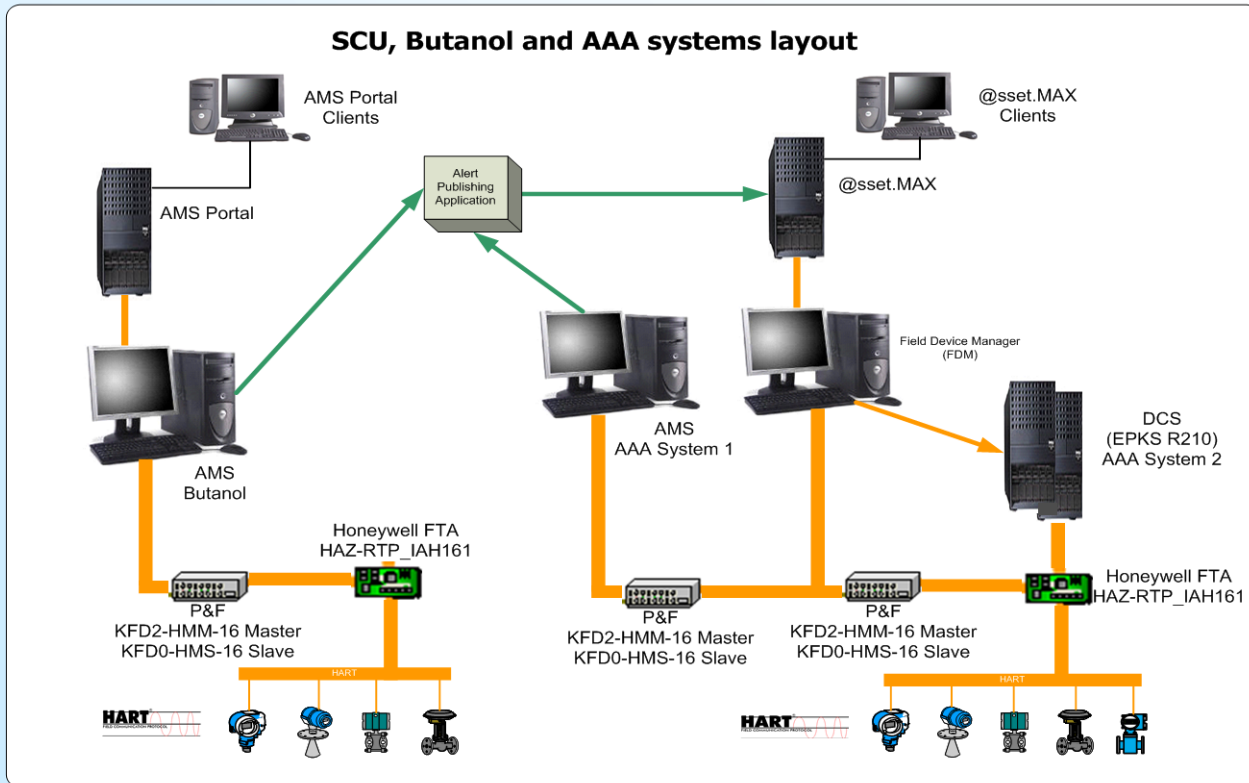

HART data is collected from intelligent instruments and conveyed to the process control system and asset management operator stations via HART flexible interface and via RS-485 from I/O to operator stations.

The mix includes multiplexers, shutdown and control valves, and pressure and temperature transmitters. Claassen uses the intelligence and diagnostic capabilities in these instruments for predictive maintenance strategies, root cause failure analysis, and fault tree analysis.

By using the diagnostic capabilities on the control valves, his group has determined which valves should be removed, targeting 40 out of 350 at a savings of over a million Rand. They've also detected faulty or poorly optimized valve positioners at a savings estimated to top two million Rand.

There are also advantages to the new systems that are harder to quantify. Claassen recalls that, after installing the latest asset-management portal-software, the acrylic acid plant went through a scheduled shutdown in September 2005. Using the asset management portal, Claassen and his team could give the production department an update on the health status of all field instrumentation and control valves before restarting the plant.

This was not possible before because it was not easy to tell how well quality-assurance and quality-control tasks were done during the shutdown. Thanks to the new technology, Claassen was able to provide an answer much quicker than before.

"In less than five minutes I could give my production department the go-ahead to start up the plant. Before we had HART and the new software packages, it was very difficult to do this. You had to rely on the information that your people could give you," he says.

Results obtained through the use of intelligent instruments have been so encouraging to this point that Sasol plans to deploy similar systems in the company's other plants over the next few years.



2005 HART Plant of the Year



ORBCOMM USES HART COMMUNICATION IN SATELLITES TO TRANSFER DATA

PROJECT OBJECTIVES

- Find a low-cost communications solution for satellite transceivers sourced from multiple manufacturers

SOLUTION

- HART technology equipped the full 28-satellite network for remote asset monitoring applications
- Provide a method for customers to transmit critical data from offshore pipelines, remote well heads, tanks or flowmeters

RESULTS

- Critical data easily, efficiently transmitted from the field to 500 miles 'up,' via Internet or file transfer
- Rapid, fully-configurable data transfers and remote diagnostics for a wide variety of applications in the upstream oil and gas market

ORBCOMM Global, the first low-Earth orbit (LEO) satellite provider of data communications services, helps its customers transmit wellhead pressures, natural gas production and tank levels

It's official. HART Communication is "out of this world." Since 1999, ORBCOMM Global has successfully used the HART Protocol to transfer data from HART field devices to low-Earth orbit (LEO) satellites. Still flying high today, ORBCOMM's Controlsat FieldSentry RTU continues to support two-way message traffic with HART-enabled field devices through the company's satellite network.

"ORBCOMM Global became the first commercial LEO provider of data communications services when we completed our 28-satellite constellation in September 1998" says Wally Walter, Controlsat product manager. "The network was designed to be a low-cost communications solution with typical messaging fees between 10 and 50 dollars a month (*circa 1999*) and affordable satellite transceivers available from five major manufacturers."

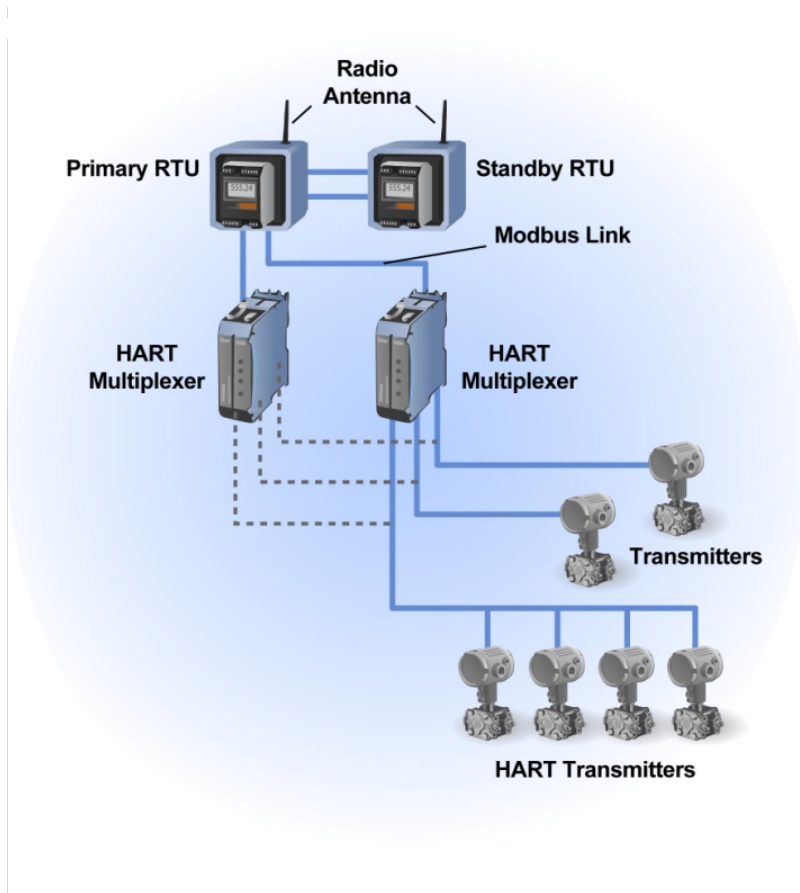

HART Communication plays a pivotal role in ORBCOMM’s strategy for remote asset monitoring. With the HART-based FieldSentry, rapid, fully-configurable data transfers and remote diagnostics are possible for a wide variety of applications. The FieldSentry is in service now providing remote diagnostics via satellite of wellhead pressures, natural gas production and tank level monitoring for the upstream oil and gas market.

Unlike expensive, high altitude Geostationary Earth Orbit (GEO) satellites, the new LEO satellite technology places a constellation of small, inexpensive satellites in continuous motion at approximately 500 miles altitude. This reduced distance lowers the power requirements dramatically and greatly simplifies the transmitter design.

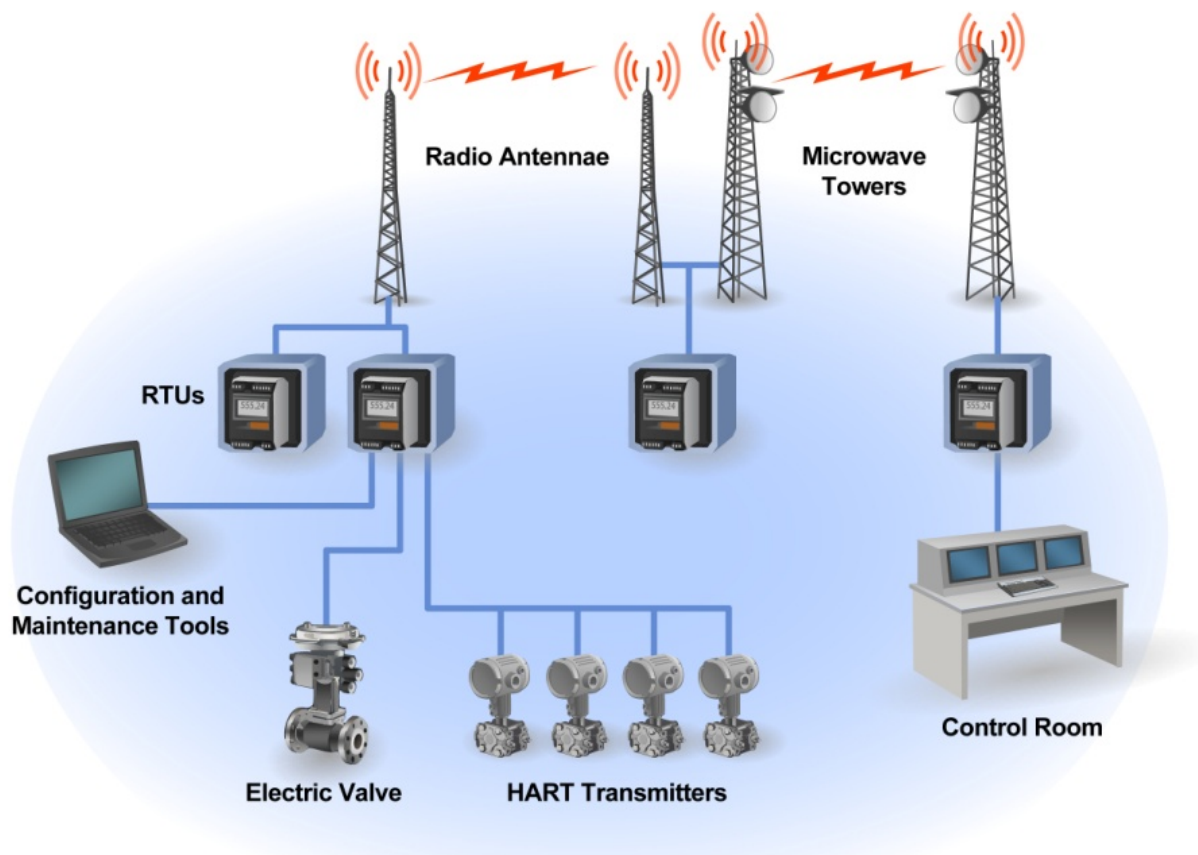

“This system allows us to transmit critical data from offshore pipelines, remote well heads, tanks or flowmeters to distant clients via Internet or file transfer,” Walter says.

In this “out of this world” application, the HART Protocol has proven itself once more to be a highly capable, cost-saving process management tool. Many new HART-compatible products, like the FieldSentry, are making remote operations—data transfers, diagnostics, monitoring and measurements—easy and efficient.



BP CANADA ENERGY USES HART COMMUNICATION TO IMPROVE PROCESS CONTROL AND SAVE MONEY



PROJECT OBJECTIVES

- Achieve accuracy between 0.1 and 0.2 percent in custody transfer of oil as it changes ownership en route to and from sites across Canada's oil-rich Alberta province to meet contractual requirements

SOLUTION

- In roughly a decade, a majority of the 600 transmitters were upgraded with HART devices and flow computers handling up to four transmitters each
- HART Communication provided an all-digital data path, eliminated the need for conversion when analog-to-digital conversions were resulting in metering inaccuracies
- Transmitters were also upgraded for greater accuracy

RESULTS

- HART-enabled transmitters helped improve accuracy to save almost a quarter-million dollars annually
- The plant achieved higher performance using upgraded transmitters and flow computers that did not require analog step in obtaining measurements
- Marcel Boisvert, senior instrument/electrical craftsman, credits HART Communication with "fantastic" measurement balances and "phenomenal" accuracies
- Engineers and technicians saved time by reducing trips to the field

*Making use of the digital process variable output of HART-enabled transmitters, **BP Canada Energy** improved its process control and saved substantial time and money.*

Just as all roads once led to Rome, today all pipelines lead to Fort Saskatchewan – at least those carrying hydrocarbons in the middle of Canada’s oil-rich Alberta province. The pipeline hub is the BP Canada plant located in the city. “We have just about every pipeline in central Alberta coming in and out of Ft. Saskatchewan,” says Marcel Boisvert, a senior instrument/electrical craftsman with BP Canada Energy.



BP Canada Energy Plant - Fort Saskatchewan

The material in the pipelines not only moves through the area but also changes owners. BP Canada Ft. Saskatchewan does the custody transfer measurement, and getting those readings right presents a challenge. However, thanks to hard work and HART Communication technology, Boisvert reports, "Our measurement balances are fantastic. Our accuracies are just phenomenal."

The plant’s engineering staff put the digital process variable output of HART-enabled transmitters to use, thereby improving accuracy, saving up to a quarter million dollars annually, and earning HART Plant of the Year honors for 2006. There is a tale interest for anyone who wants to know how HART technologies can help improve processes.

Balancing the Books

The Ft. Saskatchewan plant makes propane, butane, natural gas liquid (NGL) condensate and ethane with carbon dioxide removed. In a given year, 1.5 million cubic meters of propane leaves the plant, bound for other BP facilities. The other products produced also ship in large volumes. The plant staff employs temperature and pressure readings to compensate the flow measurement and quantify what's in the pipes.

A decade ago BP Canada started installing HART-enabled temperature and pressure transmitters in Ft. Saskatchewan. Today a majority of the 600 transmitters in the plant are HART-enabled. As part of the upgrade package, the company also installed flow computers, up to four transmitters per computer.

In the initial configuration, Boisvert says the 4-20 mA analog signal output from a transmitter was fed into a flow computer. The digital signal superimposed atop the analog signal as part of the HART standard functioned as a second communication channel to and from the transmitter but was not being used by the flow computer.

For audit and other purposes, flow-computer readings were and are compared to that of a standard, certified gauge. One plant staff person handled transmitter calibration while another did the meter proving. The accuracy in the mass delivery demanded by contract was one or two tenths of a percent, a figure that translated into a need for highly accurate temperature and pressure readings.

For example, a temperature error of 0.25 °C results in up to a 0.07% net flow error. Multiplied by the amount of product Ft. Saskatchewan ships, that error meant a potential loss of \$250,000 a year. For NGL, the corresponding figure was \$350,000, creating strong incentives for accurate measurements. In addition, those receiving the product would make their own readings and take action if a large enough difference was found. "There will be a correction, if you have somebody at the other end able to do the measurement as well as you do or better," says Boisvert in explaining what would happen.

Speaking one language

Problems, however, cropped up when Boisvert and coworkers tried to reduce the measurement error. Despite diligent transmitter calibration efforts that should have kept the devices operating within a tenth degree, meter proving continued to indicate an inaccuracy of up to half a degree. The employee proving the meter would then adjust the transmitters or ask for them to be calibrated. Calibration showed that the transmitters were working well within tolerances. The sequence would then repeat for each employee's area until various team members witnessed each.

The team finally found the problem to be within the flow computer, specifically in the transformation of the analog signal into its digital equivalent. "The analog to digital conversion was not as accurate as what we were looking for," notes Boisvert.

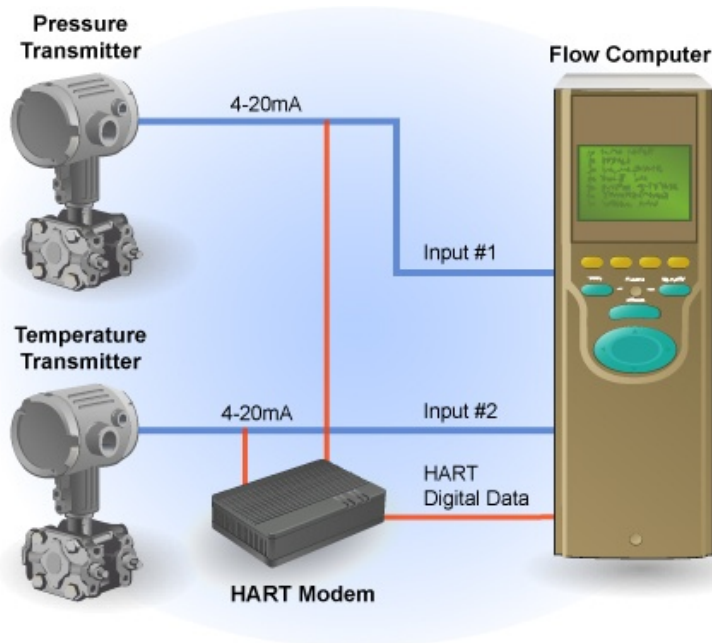

The errors weren't great, perhaps 0.2 to 0.5 °C on a range of -18 to +65.5 °C. On the pressure side, the discrepancy might be up to 50 kiloPascals on a range of 10,000 kPa. Those small errors, though, were enough to eat up a significant part of the overall allowable error budget.

Faced with this problem, the team started looking for a solution. A series of tests convinced them the readout at the transmitter agreed with analog and digital signals. That was when the group decided to sidestep conversion, notes Boisvert. "If the flow computer speaks HART and the transmitter speaks HART, let's read the digital value rather than the analog value," he says, thinking through the process.

The simple-sounding idea required a bit of work. For one thing, the flow computer's model didn't natively read or write HART commands. However, it was programmable at a low level. The vendor provided what was essentially a translator, allowing Ft. Saskatchewan's team to worry only about the higher level application software.

Part of the solution also involved upgrading the transmitters. A typical specification for a transmitter of 0.5-degree accuracy wouldn't work. "We were looking for that 0.2 degree accuracy," says Boisvert. Working with vendors, they found transmitters that would hit the more stringent spec. Such a tightening only made sense, though, because the conversion-induced error had been eliminated.

Highly accurate results

With transmitters and flow computers talking without an analog step in the middle and with more accurate transmitters, the Ft. Saskatchewan plant achieved the desired performance. It's hard to pinpoint an exact dollar figure saved due to the improvement because, as Boisvert notes, the error could have been positive or negative. The total amount of the possible adjustment, however, runs in the

hundreds of thousands of dollars a year. Since the setup has been in place for a decade, potential savings are in the millions of dollars.

Another benefit even harder to quantify has been removal of internal inconsistencies. That has contributed to creation of a well- deserved reputation that helps in certifying measurements to external parties. “There are never any issues about our accuracy,” says Boisvert.

There’s also been some savings of engineering and technician time. To take one example, the old meter proving required one employee to take a reading from a certified device placed next to the transmitter. The staffer would then have to go to where the flow computer was located and see what it measured.

Finally, the employee would have to travel back to the certified instrument and hope there hadn’t been a process change during this back and forth. Now the task is much easier because the transmitter’s digital display shows what the flow computer sees. “He can look at the certified device sitting right next to the digital display on the transmitter and compare his readings,” notes Boisvert.

There are also time savings because instruments aren’t being tweaked, and other adjustments aren’t being made only to be undone later. BP Canada Energy estimates total savings of at least an hour a week of engineering and technician time.

As for lessons learned by the whole process, Boisvert cites one that could apply to a wide variety of situations. “HART is not just a maintenance tool. It is a process improvement tool as well,” he says.



2006 HART Plant of the Year



INRA USES HART COMMUNICATION TO GAINING HIGH RESOLUTION PROCESS VALUES

PROJECT OBJECTIVES

- Optimize the number of process variables that can be cost-effectively measured inline
- Obtain an accurate data feed for math modeling of multivariable parameters

SOLUTION

- In addition to direct data measurements, use HART-enabled multivariable transmitters for proprietary math models used in real-time process optimization

RESULTS

- HART Communication-derived data leads to predictive process models, resists electrical noise
- Wiring and device maintenance require minimal investments
- Measurement quality is “superb, “accuracy is excellent“ and “the analog path in the measurement chain is shorter” _ INRA reports

French agro-food researchers use HART technology to create a mathematical model with high resolution real-time HART process values

Researchers at the National Institute for Agronomic Research (INRA) in Thiverval-Grignon, near Paris, France, are using HART Communication for inline measurement of key parameters in microbiologic processes as they occur during the production of yogurt, beer and wines. The French researchers are also acquiring valuable data required for the calculation of fermentation rates inside tanks, determining sugar and ethanol concentration, and obtaining indirect pH measurements during yogurt maturation through mathematical models developed by INRA.

“We are a state research lab, but we market the information gained in our labs to industrial production plants throughout Europe and worldwide,” says Bruno Perret of INRA’s Department of Food and Fermentation Engineering. “We use pilot plants, where we experiment with fermentation processes.”

According to Perret physical parameters are difficult to measure because many of INRA’s biological process parameters require inline measurements that are physically challenging to achieve in a cost-effective manner. In addition, it is hard to find a sensor that is reliable and inexpensive, as is the case in

pH measurement during yogurt production or in measuring alcohol and sugar concentrations during fermentation in breweries and wineries.

"Therefore, we have developed software packages with mathematical models that receive real-time digital measurements from HART multivariable transmitters to calculate these values," Perret says.

Specifically, according to Perret, process values from the multivariable transmitters are filtered (mean value) locally in the transmitters for a better stability of the measurement, using the HART transmitters integrated output damping functions. This is more efficient than having filtering done by the host software, and especially avoids bottlenecks in the digital communication rate, which is limited in a multi-drop network. The result is better resolution and stability of measurements, which would be much more difficult to achieve making evaluations based solely on analog transmitter outputs.

"Our process control is much more efficient with HART Communication. In fact, our model is so accurate that simply changing a few parameters makes it possible to predict the process evolution," Perret says. This last point is particularly important when the electrical environment of a factory is noisy.

INRA has two trademarked HART software packages with HART technology-derived master capabilities: Oeno-Beer Control, which is used to manage ethanol concentration and density; and YAB, a specialized in-line pH estimation and trending routine used in yogurt production.

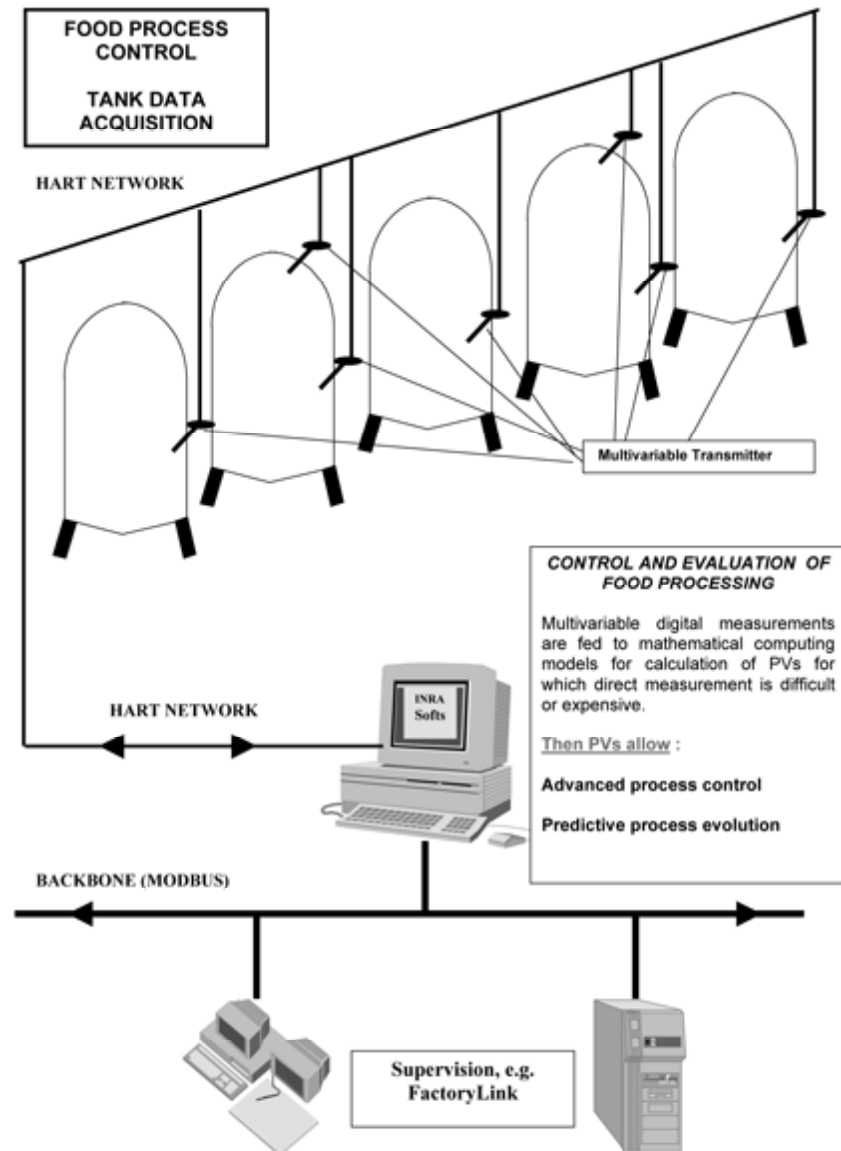

"With HART, the wiring is simple and economical, and measurement point maintenance is easy. So, operating costs are low," Perret says. "But the best thing is HART instruments have a superb measurement quality. The accuracy is just excellent. Most importantly, with HART digital data transmission, the analog path in the measurement chain is shorter."

INRA was founded in 1946 and became a national public scientific and technological establishment in 1984 under the joint authority of the French Ministries of Research and Agriculture. Today INRA operates 260 research centers, 80 experimental units and technological facilities and 100 service units.



CEBRACE USES HART INTERFACE FOR ASSET MANAGEMENT INTEGRATION

PROJECT OBJECTIVES

- Improve plant maintenance by increasing volume and quality of data received from equipment
- Integrate data from HART-enabled devices in conjunction with data from a Foundation fieldbus (FF) network in a single plant asset management software system

SOLUTION

- A HART-to-FF gateway brought data from both protocols together in a single plant asset management software system
- An additional converter added full access to valve positioner variables for advanced diagnostics
- A profusion of cable types, lengths, impedances...

RESULTS

- Plant gained access to data from multiple protocols in an integrated, Web-enabled, asset management application system
- Smart valve-positioning diagnostics further improved and loop operation and downtime avoidance

“The benefit for us was the ability to pull all our process information together, improve maintenance quality, and, most importantly, improve our mean time between failure,” the user reports

HART Communication proves a familiar, practical diagnostic solution that can coexist with Foundation fieldbus networks – and integrate well in a single plant asset management software environment

As part of a major upgrade to their plant in Sao Paulo, Brazil, **Cebpace** Cristal Plano, a large plate and specialty glass manufacturer, sought to improve overall plant maintenance quality by increasing the volume and quality of data received from plant equipment.

Although a Foundation fieldbus (FF) network was already in place in the plant, Cebpace engineers chose to rely on instrumentation using HART Communication to enhance data retrieval in their maintenance

and diagnostic system. “Our plant technicians are more familiar with HART technology and feel more comfortable relying on its proven capabilities in critical situations,” says Benedito Adalberto Pestana, Cebrace Automation Systems Coordinator.

Using an off-the-shelf gateway between the HART and FF protocols, operators were able to view and control instruments on both networks from the same plant asset management software system. The software allowed the user to apply several tests via HART, such as partial/complete stroke, valve signature, step response, mileage/stroke/reversal tracking, and input/output pressure checks. All these features allow analysis, alarm/warning generation preventing problems by identifying them before they occur.

“The benefits for us were the ability to pull all our process information together, to improve maintenance quality and, most importantly, improve our mean time between failures,” says Pestana.

DESIGNED SOLUTION

Because of the advanced diagnostics demanded by this project, achieving a complete HART-to-FF technology conversion, comprising Universal, Common Practice and Specific commands, required accessing all the valve positioner variables. To do this, Cebrace engineers selected a HART-to-FF converter since an analog signal is not required when the control strategy is being performed via a third party programmable controller (see diagram).

Since there were a small number of positioners in the system, Cebrace engineers placed all ten converters into a single battery of backplanes inside the control room instead of distributing them in the field. One cell was also installed next to the converter sets and interconnected to the network via a fiber optic cable with one FO/ETH converter at both ends.

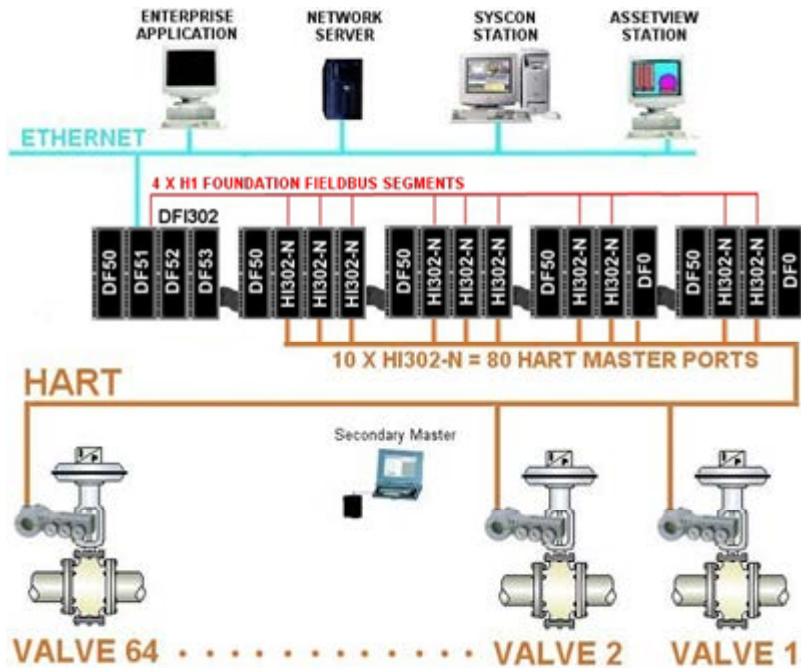

The proposed architecture to address the problem

A derivation was taken from every cable to connect each positioner to the converter's eight HART master ports. Even with such a wide variety of cable types, lengths and impedances, no operational problems were detected after the installation was completed.

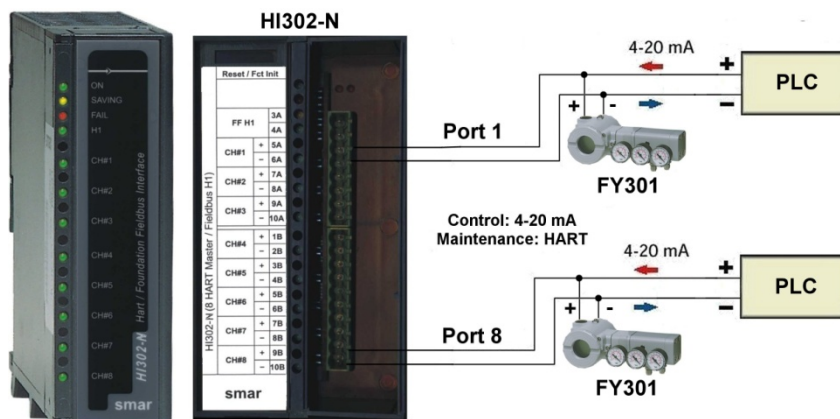

The installation scheme of each positioner

ASSET MANAGEMENT

“Our manufacturing facility is built around a huge linear machine hundreds of meters long. Any disturbance, especially in the initial stages of the production process, can cause a major shutdown and, even worse, destroy the main oven,” Pestana adds.

“If this occurs, set up and restart lasts a minimum of 60 hours, which represents a cost of about \$30,000US in lost product. Through the use of HART technology, we are able to maintain online preventive maintenance full time and reduce maintenance costs at least 50 percent.”

HART integration allows Cebrace to monitor process-related variables, diagnostic status, and information stored in their database, such previous operation conditions, next scheduled shutdown for maintenance, etc., 24 hours a day, seven days a week. They are able to access all field devices from every station plant-wide and even worldwide (if an Internet connection is available) in a single, web-based, integrated software environment to improve loop operation and to avoid unscheduled downtime.

CONCLUSION

The main benefit of this integration project was that the plant gained access to data from all fieldbus as well as HART-enabled devices, in a single, integrated asset management application, at every station in the plant as well as remotely using a secure Internet connection.

The high level of diagnostic data available via the HART smart valve positioner additionally allowed access to information needed to improve loop operation and to avoid unscheduled downtime.



2003 HART Plant of the Year - FINALIST

GAS PIPELINE COMPANY USES HART TO MODERNIZE OPERATIONS AND SAVE \$1.25 MILLION ANNUALLY

PROJECT OBJECTIVES

- Replace paper chart recorders with cost-effective digital communications
- Extend automated meter-reading to a wireless network with an 80-mile radius.
- Extend the HART Communication network beyond the traditional 10,000-foot (3,000-meter) distance limitation.

SOLUTION

- Installed HART-enabled network gateway/multiplexer for use with a multivariable flow transmitter providing flow measurement and data logging
- Spread spectrum radios provided the wireless link, with multipoint and repeater configurations, between the network gateway and the HART-enabled instruments

RESULTS

- Reliable data acquisition from devices within a radius of up to 80 miles to a central host in Tulsa, Oklahoma
- Data easily integrated with the pre-existing measurement system.
- Eliminating manual paper-based operations saves an annual \$1.25 million
- Additional savings include elimination of costly cable runs and hardware savings of almost 30% on future instrumentation installations

When a major Midwestern gas pipeline company sought to modernize its legacy paper-based meter-reading operations, HART technology proved equal to the challenge by providing a capable, flexible and cost-saving solution.

In an extraordinary automation project involving multiple “wireless” messaging links, the power and adaptability of the HART Communication helped a major Midwestern gas pipeline company meet the challenge of modernizing its analog meter-reading infrastructure. HART technology provided the communication tool needed to create an extended meter reading network via spread spectrum radio and satellite communication.

The gas pipeline company planned to replace paper chart recorders on their natural gas pipeline with an automated meter reading (AMR) system. The AMR system would have to be capable of acquiring data from devices within a radius of up to 80 miles, publishing field data from locations throughout the Midwest to a central host in Tulsa, Oklahoma, and integrating the data with an existing measurement system.

To meet the challenge, company engineers chose the Director, a HART-enabled network gateway/multiplexer from Arcom Control Systems used in conjunction with a multivariable flow transmitter providing flow measurement and data logging capabilities.

“The HART master satisfied all the requirements for the project,” says John Tandy of Arcom Control Systems. “The Director uses HART to acquire real-time and historical information. Data is then published to a central host via satellite or over Ethernet via TCP/IP.”

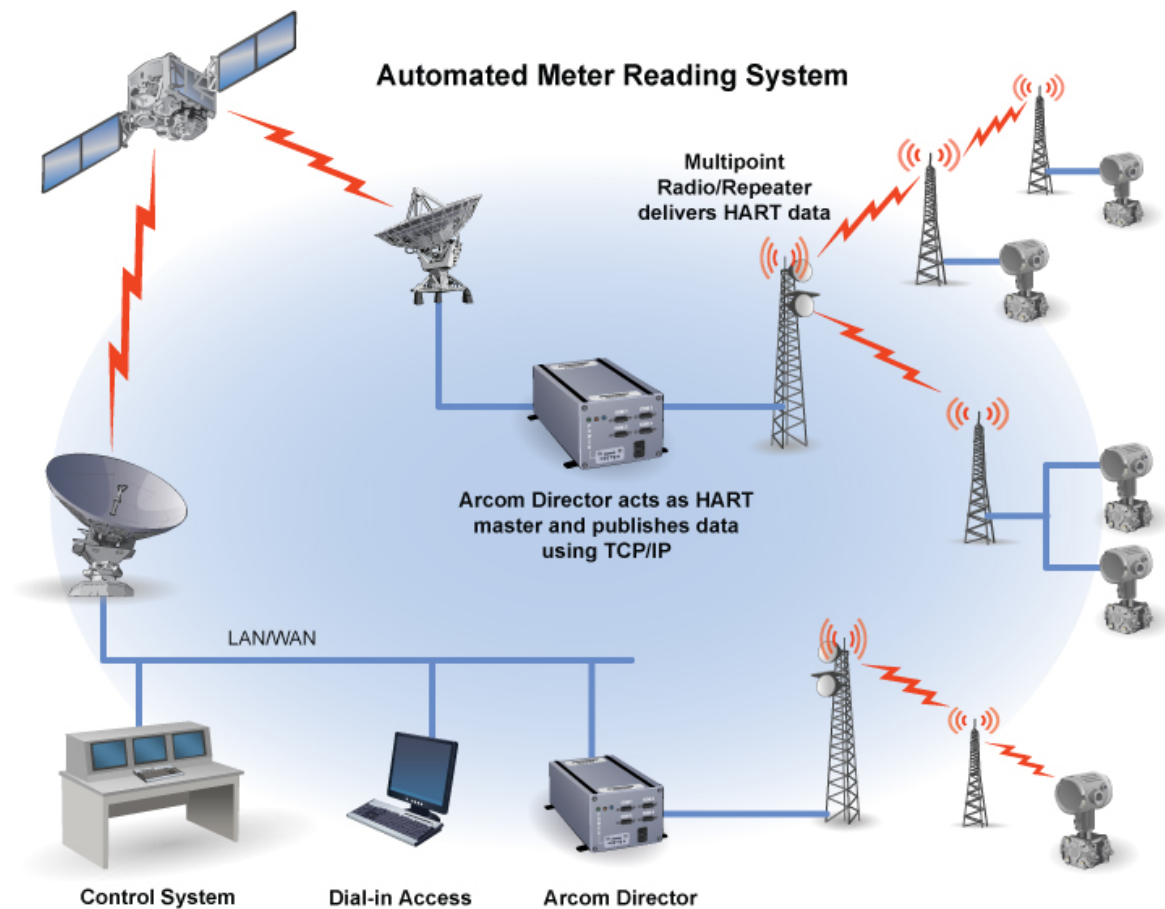

The AMR system uses spread spectrum radio and satellite communication to extend the HART network beyond the traditional 10,000-foot (3,000-meter) distance limitation. Spread spectrum provides the wireless link between the Director and the HART instruments.

Tandy adds that the radios “allow great flexibility in network architecture through multipoint and repeater configurations, as well as providing reliable data transmission of the HART messages,” Tandy

adds. "With the use of repeaters, HART units can be brought into a single multiplexer from a radius of 80 miles or more."

At each remote site the Freewave radio connects to the field devices using a serial HART interface. This transmits the HART signal from the radio onto the local current loop to a single or multi-dropped HART network. Because up to 32 devices per radio network were required, the HART "poll by tag" feature was implemented to allow more than the traditional 15 devices.

By implementing the HART-based AMR system, the pipeline company was able to realize cost savings in several ways. The paper chart recorders previously had to be collected and tabulated manually for each monthly billing. Now this is done automatically with ongoing savings estimated at \$1.25 million per year. Because the HART signal is transferred over the radio link, there is no need for a separate Remote Terminal Unit (RTU) or multiplexer at each meter site. One Director is master to 32 HART meters, allowing data consolidation.

Wireless communication avoids very costly cable runs to each HART meter. The multivariable flow transmitter effectively combines a traditional flow meter and three discrete instruments into a single instrument, yielding hardware cost savings of almost 30% per site. TCP/IP communication allows remote diagnostics and configuration, reducing the need for on-site technical support.

Global industry growth continues to present an ever-increasing challenge to provide strong networking and interoperability communications solutions. HART technology has demonstrated for more than a decade that it is capable of meeting the challenge.

HART-TO-ETHERNET GATEWAY: TWO DIVERSE APPLICATIONS, ONE SOLUTION

What does a large refinery have in common with a 650 year-old wheat mill? A common HART Protocol and a simple solution to a sometimes complicated problem in the HART-to-Ethernet gateway.

Numerous automation suppliers offer off-the-shelf gateways to bridge the data divide between the HART protocol and many industrial Ethernet protocols. These gateways provide a highly effective means of bring data from HART devices in the field and any host computer or device on the Ethernet network.

Consider these two very different plant environments...



REFINERY – MEXICO

PROJECT OBJECTIVES

- In Mexico, a **PEMEX** refinery required a means of integrating of all HART-compatible field devices into one user program.

SOLUTION

- Installed autonomous 100Mbit Ethernet Network (HART-LAN), ring topology with optical Ethernet ports, conversion from RS485 using COM servers and HART LANs to accesses devices

RESULTS

- Each satellite room got a COM server; RS485 bus line extended as a two-wire cable as a bus line connecting to HART multiplexer; HART Server automation interface allows user monitoring.
- PEMEX refinery uses HART-to-Ethernet Gateway Web Server to integrate 10,230 analog inputs and 2,430 analog outputs to satellite rooms up to 3 kilometers away

Faced with a daunting integration task, the PEMEX refinery in Madero, Mexico, turned to HART Communication for a viable solution. A part of the overall requirement of the project was the full integration of all HART-enabled field devices for parameter assignment and configuration into one user program.

Access to these field devices had to be via both a central computer with a back-up system and individually using a Notebook in each individual satellite room. This involved the transfer of a total of 10,230 analog inputs and 2,430 analog outputs via 728 HART multiplexers (211 masters, 517 slaves). Distance to the individual satellite rooms was up to 3km.

In order to effect the required functionality, engineers decided in favor of an autonomous 100Mbit Ethernet Network (HART-LAN). A ring structure topology was selected with automatic redundancy switchover. The ring structure was achieved by interconnecting the optical ports of the Ethernet switches in the CCR bunker.

Successful conversion from Ethernet to RS485 interfaces in the satellite rooms has been achieved through the use of COM servers. These devices are set to a specific IP address and can be addressed through the corresponding device driver via Ethernet as an outlying RS485 interface. Thus, every station on the HART LAN has access to these devices, which proved to be an excellent solution for individual access via the Notebooks.

One COM server has been installed per satellite room and the RS485 bus line has been extended as a two-wire cable. Up to 15 HART multiplexer masters are connected to this bus line. The central computers and the Notebooks are equipped with seven software packages, including the HART Server automation interface.

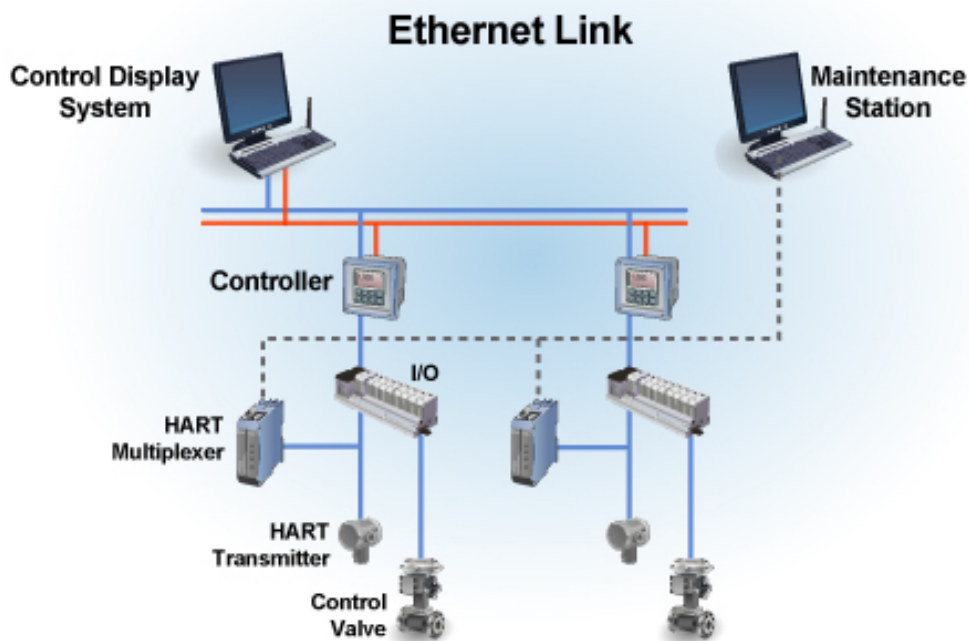



PROJECT OBJECTIVES

- Ancient German wheat mill needed to transfer radar level-sensor data from silos to the control room

SOLUTION

- HART-to-Ethernet Gateway acts as a Web server, sending data via wireless LAN to control room

RESULTS

- Process variables displayed in standard Web browser; no new cabling needed to bring data to control room.
- In Germany, the H. Thylmann Kilianstädtermühle wheat mill needed to transfer radar level sensor data from silos to the control room.

A 650-year-old wheat mill near Frankfurt, Germany, is now linked with 21st Century process automation thanks to the power of HART Communication used to send data from silos to the mill's control room via a standard Web browser.

The H. Thylmann stores bran in six silo tanks of 40- to 60-ton capacities. The mill equipped the silos with guided radar level sensors that monitor tank levels. A HART-enabled multiplexer scans and collects the analog and digital data from the level transmitters.

The data is fed to a HART-to-Ethernet gateway which acts as a web server. The data is then transmitted via a wireless LAN to the control room located about 40 meters away and displayed as process values by using a standard Web browser.

“There was no new cabling to the control room needed,” says Thomas Funfgeld, the mill's instrumentation manufacturer representative. “All equipment could be mounted in a single cabinet near the silo tanks. Also, the HART data is available via the network to all users in the company.”

Visualizing the data with a standard Web browser saves additional money because custom display software is not required. This is another example of how HART Communication, when used in a real-time process application, can provide simple, cost-effective solutions that can reduce operating costs and improve process operations.

PDVSA USES HART TECHNOLOGY TO STREAMLINE PREVENTIVE MAINTENANCE PROCESS

PROJECT OBJECTIVES

- Achieve trouble-free plant startup of a 248,000 barrel/day oil processing facility
- Eliminate erratic performance of under-performing field devices in a DCS network of 5,000 instruments

SOLUTION

- Addition of asset-managing software system platform to its DCS
- Use the combined platform's HART technology to access intelligent device diagnostic information and root-out "bad actor" devices to be eliminated and/or replaced

RESULTS

- Streamlined work processes led to reduced maintenance costs for a 60% reduction in lost profit opportunities valued at \$70 million in two years
- Instrumentation performance and calibration problems were prevented before startup. Number of failures attributed to instrumentation during startup? Zero
- Since startup, HART technology has streamlined preventive maintenance, allowing this large plant to operate with a staff of only five reliability engineers and 12 instrument technicians

One of Venezuela's major producing oil fields lies in its Orinoco River basin; however, crude from this field is extra heavy and must undergo upgrading in one of several plants before refining. One of those plants is using HART Communication to streamline operations and their preventive maintenance process.

The Petropiar Mejorador (upgrader) facility in the José Antonio Anzoátegui industrial complex near Barcelona, Anzoátegui, Venezuela, is controlled by PDVSA (the Venezuelan national oil company) in a joint venture with Chevron. It begins with the tar-like feedstock at 7.5 °API, and turns it into 26 °API synthetic crude. The plant first started operation in 2003 as Petrolera Ameriven, and began delivering product in January, 2004. By the middle of that year, it achieved normal production, with capacity rated at 248,000 barrels per day with 1,500 employees.



As in any oil processing facility, reliability is paramount, and with 5,000 instruments communicating with the DCS, eliminating problems from erratic devices was key. To achieve that, Petropiar added an Asset Management System platform to its DCS. This system uses HART technology to communicate intelligent device diagnostic information from instruments and actuators throughout the plant.

“Since our plant went on line in 2004, HART technology has opened a door of opportunity to the reliability community,” says Mariela Leon, Petropiar instrumentation reliability leader. “We were able to optimize our work process creating a reduction of maintenance costs which led to a 60% reduction of lost profit opportunities (LPO) caused by instrumentation faults. Eliminating bad actors and having the ability to reduce random failure has resulted in a reported reduction of LPO on the order of \$70 million in two years.”

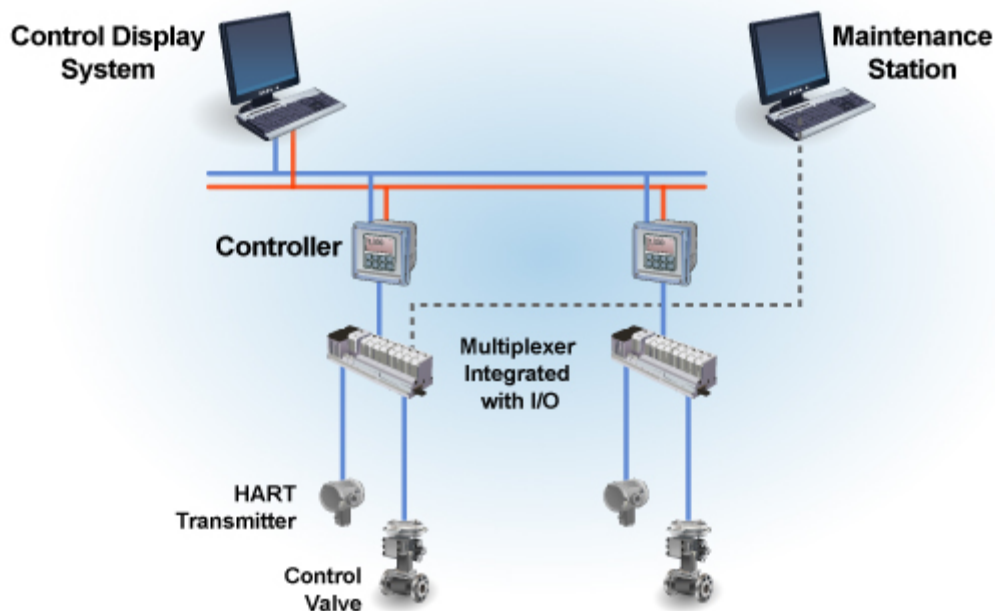

Petropiar’s maintenance group found that their efforts using HART technology made the plant startup go much smoother, as instrumentation performance and calibration problems had been sought out and corrected before it went on line. As a result, there were no failures attributed to instrumentation

reported during the startup period. Their bad actors had already been identified and corrected, eliminating 95% of related problems.

Since startup, this preventive method has continued. Calibration tasks are thoroughly defined, with routes and schedules laid out for the entire universe of instrumentation. This emphasis on predictive maintenance allows them to attend to only the items that really need attention, resulting in a 10% increase in effective personnel “wrench time.” This has allowed the plant to operate with a staff of only five reliability engineers and 12 instrument technicians and still stay ahead of most problems.

These experiences have caused the reliability team to look for other opportunities where HART has not already been put to work. There is still a small population of installed devices that are not HART capable, but these will be upgraded. All new instruments and process analyzers must be HART compliant.

Moreover, all systems have not yet been integrated into the AMS, but this is also underway. Some parts of the safety instrumented system (SIS), some PLC driven subsystems, and the fire and gas (F&G) detection system are still being incorporated into the larger asset management network.

One example of this increased reliability relates to valve positioners. “HART technology was used to pinpoint a bad valve positioner which provided the justification to change or add positioners to 400 valves,” says Livia Lefebre, reliability superintendent. “We also demonstrated the partial valve stroke application to management who then approved its use, significantly increasing the time between required shutdowns.”

HART technology is also used at the oil production site that feeds Petropiar, and by the end of 2008 the two systems will be interconnected. This will allow the reliability engineers at the upgrader to analyze what’s happening upstream as well.



2008 HART Plant of the Year



SHELL USES HART COMMUNICATION TO IMPROVE NIGERIAN PLANT OPERATIONS

PROJECT OBJECTIVES:

- Improve on plant operation to increase throughput
- Improve maintenance efficiency

SOLUTION:

- HART devices and communications installed across the plant's field instrumentation and control networks for real-time process monitoring
- Use of remote HART communications for maintenance activities

RESULTS:

- Remote access to hard-to-reach places reduces the time and cost of trips to field devices
- Shortens time for instrument installation and configuration in half...or better
- Improves plant operations and maintenance through greater data visibility

HART Communication has sped instrument installations as well as maintenance jobs for Shell Petroleum Development Company Nigeria, for improvements to operations and maintenance in the Soku Gas Plant located in Port Harcourt, Rivers State, Nigeria.

Shell Petroleum Development Company Nigeria, needed to “improve on plant operation and maintenance and to increase throughput,” says Awe Kayode, leader of the effort to bring HART benefits to the company's Soku Gas Plant.

The Solution

Devices equipped with HART communications were installed across the plant's field instrumentation and control networks for real-time process monitoring. Additionally, HART communication is used for preventive maintenance and first-line maintenance jobs.

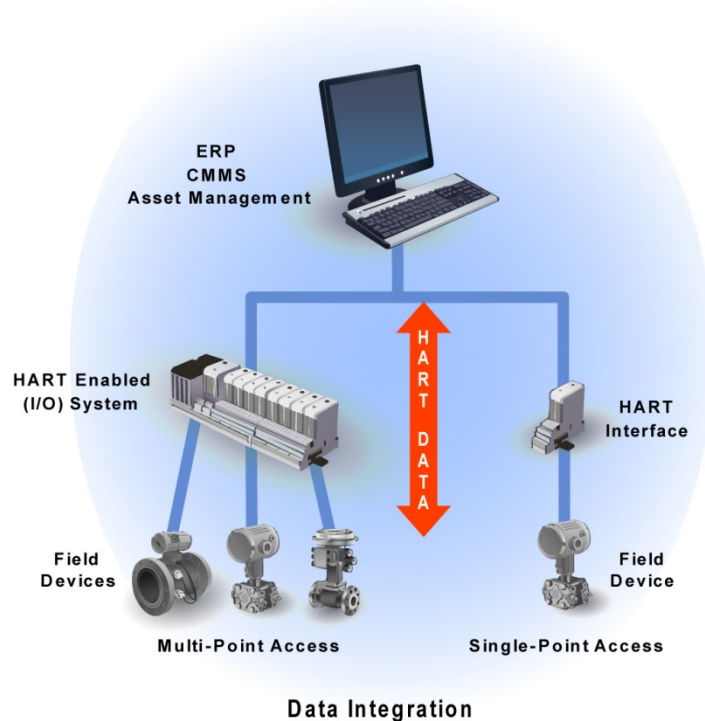

HART Communication made it easier to access the instrumentation in hard-to-reach areas such as the plant's glycol regeneration skids where technicians would otherwise climb ladders. Kayode explains that the HART capability has helped the maintenance staff comply with its goals, which has had a "direct impact in keeping our plant running."

Benefits and Outcomes

The use of HART technology "has greatly reduced set-up and configuration time of field devices," Kayode says, citing the installation of new transmitters at the Soku plant's Enhanced Gas Gathering System: "The configuration time was initially scheduled for seven days, but was completed in three days."

Additionally, remote communications access has "greatly reduced" trips to the field. Instead of climbing ladders to access instruments on a glycol regeneration skid, HART technology speeds access while reducing time, cost and risk.

Kayode adds that plant work processes and operations have been “greatly improved” through the better data visibility the HART Protocol provides, which he sums up as “knowing the status of field devices and be able to be proactive in their maintenance.”

STATOIL USES HART COMMUNICATION TO DELIVER NATURAL GAS FROM UNDER THE SEA

PROJECT OBJECTIVES

- Optimize efficiency in communicating data from an undersea gas field of 24 wells to a 1,200 km long undersea pipeline—the longest ever built
- Minimize the staff required to effectively manage communications with the control system

SOLUTION

- An distributed control system was installed with secondary controllers at substations to handle the interfaces with field devices
- Approximately 1,400 HART-enabled field devices were connected to the system full-time
- Several traditional 4-20mA anti-surge valves were connected to HART multiplexers to allow their data can be converted for communication
- A videoconferencing application lets experts around the world collaborate on diagnosing and correcting problems as they arise

RESULTS

- HART technology helped the plant meet a commissioning schedule
- Diagnostic data enhance compliance with the company's Total Reliability Initiative for higher efficiency, asset availability and safety
- A full-time connection between HART-enabled devices and the control system's asset optimization package allows real-time tracking, troubleshooting and fault diagnosis

By designing in the advanced communication and self-diagnostics capabilities of HART technology, Norway's Statoil and its partners started efficiently delivering natural gas to the U.K.

When winter strikes, you need heat to beat back the cold. It would be best if the fuel were reliable, plentiful, and relatively clean burning. Now consumers in the U.K. have a new source for that heat, natural gas and condensate pumped across the ocean from Norway's subsea Ormen Lange gas field.

They'll warm water for tea, cook food, heat homes, generate power and otherwise use the fuel for years to come.



Statoil Offshore Plant – Ormen Lange

They're able to do so, in part, because of HART technology. Erling Ramberg is an automation lead engineer at the Norwegian oil company Statoil. The firm designed the onshore processing facility that produces the natural gas and condensate shipped to the U.K. He notes that the goal was to be as efficient as possible and that HART-capable transmitters and valves were chosen for this and other factors.

"It has to do with size of the plant, of course, and the location out on the island. Also, we do not want to bring in more people than required," he says.

Up from the Cold, Dark Sea

Discovered a decade ago by one of Statoil's parent companies, Ormen Lange is a natural gas field off the Norwegian coast. It's large in more ways than one. It measures 40 kilometers long and eight wide. It also has proven gas reserves total nearly 400 billion cubic meters, an amount projected to be able to supply up to 20 percent of the natural gas needs of the U.K. for the next forty years.

But Ormen Lange is not easy to exploit. The gas field itself lies roughly 3000 meters below sea level, buried beneath an uneven seabed and sitting under 800 to 1100 meters of water. Situated 120 km off the coast of Norway, the site experiences some extreme natural conditions. There are subzero temperatures, whether measured in Fahrenheit or Centigrade, most of the year. The seas are stormy, with strong underwater currents.

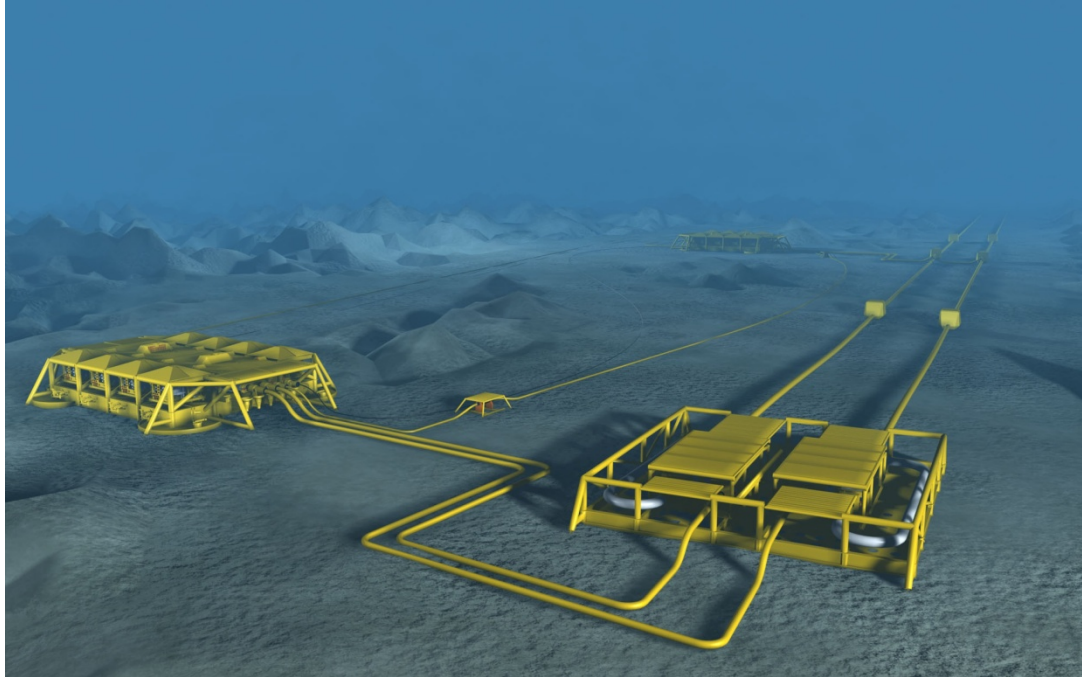

Subsea wells in seabed templates

The project that brought this fuel up from the bottom of the sea and into British homes consists of a 24 subsea wells in four seabed templates. The output of the wells is sent in pipes 120 km to Nyhamna on the island of Aukra on the west coast of Norway. There the fuel is processed and readied for shipment to the U.K. via a 1200 km long undersea pipeline.

Ramberg notes that direct pumping of the fuel to shore-based processing won't be problematic because special steps are taken to prevent pipe-clogging due to freezing of the liquid. That's done with an on-shore monoethylene glycol (MEG) plant. "We pump the MEG liquid out to the wells, inject it in the pipelines and transport it with the gas to shore to prevent freezing."

Meeting the Challenge for Less

Once onshore, the MEG is removed and reused. The fuel then has to be processed and readied for shipment to the U.K.

When designing the plant, Statoil faced several constraints. One was the remote location, another was the sometimes harsh weather, and a third was the size of the facility. As finally built, the on-shore plant is one square km, with a main control room and 10 substations. "This plant is quite

large,” says Ramberg.

An overriding concern in the design was the need for absolutely reliable operation. No one, after all, wanted a consumer in the U.K. to turn on a burner and get nothing out because of a problem with a plant across the sea. The company, quite naturally, also wanted to accomplish all of its goals as efficiently and with as little onsite manpower as possible.



Ormen Lange Onshore facility

Ramberg recalls the technology selection process. Given the constraints, the ability to do predictive diagnostics was particularly important. With that capability, the health of a valve or other component could be gauged and maintenance could be done as needed. Valves wouldn't be changed out too soon, which would waste money. They also wouldn't be changed out too late, which could potentially jeopardize operations.

There were other benefits to having a wealth of diagnostic information. With the right data, it should be possible to identify the root cause of a problem. It might then be possible to correct the issue remotely, meaning fewer personnel would be exposed to harsh weather and possibly dangerous conditions. What's more the collection of data could, over time, lead to the elimination of some problems as root causes were identified and fixes implemented.

Because of the advantages of a communication rich approach, the company selected HART Communication technology to deliver the device diagnostic information they were seeking. The finished plant has about 1400 separate HART-enabled field devices connected on-line—full time.

Of these, about 350 are valve positioners, with most of the rest transmitters. A handful of traditional 4-20 mA anti-surge valves are connected to HART multiplexers so that their data can be converted for communication.

Control is handled by a DCS with secondary controllers in the substations handling the interface between local devices and the plant-wide controller. As might be expected given the need for reliability, there are redundancies and intelligent approaches built into the setup. Some of these aren't those typically thought of or used. For example, there's a robust video conferencing capability so that experts from around the world can meet virtually to help diagnose problems and propose solutions.



After processing at the plant, the fuel begins a trek to the U.K., traveling 1200 km before arriving at a terminal at Easington at the other end. "It is a very long pipeline. I think it is the longest subsea pipeline so far," says Ramberg.

Operations Begin

He notes that startup of the operation was an activity that took some time, with an eye toward full production over a span of months. “The startup was an activity going on for weeks, but the actual startup was when they opened the valve to the well,” he says.

Ramberg adds that HART technology helped the plant meet its commissioning schedule. However, in some sense, his job is done. Starting in December, operation of the plant was taken over by project partner A/S Norske Shell, the Norwegian member of the Shell family.



Graham Baird, a condition monitoring engineer for A/S Norske Shell, will be one of those responsible for monitoring of the plant’s day-to-day operations and health. He’s had input in the design phase, particularly with regard to what’s needed for operational monitoring of intelligent field equipment condition.

While there hasn’t been a lot of operational data so far, what the HART-enabled technology has delivered is promising. Baird cites the control system’s asset optimizing package and device manager. “Early indications are that these will give us a lot of useful actionable data, as they are online systems scanning the HART-enabled instrumentation continuously,” he says.

With alert reporting activated, work can be prioritized, scheduled, and tracked. Baird notes that so far fault diagnosis has been made very quickly, thereby enabling corrective action to be taken in a controlled manner. Often, this has allowed fixes to be made directly to the root cause of the problem.

There also can be synergies with other non-HART condition monitoring systems. For example, compressor performance can be influenced by surge valve conditions, instrumentation calibrations, and so on. With more diagnostics data available, it's possible to cross reference between systems to establish why equipment may not appear to be performing according to design.

"All in all we get a much better overall view of the plant asset condition right now" sums up Baird.

He explains that the use of HART technology and the wealth of diagnostic information it provides aligns with Shell's Total Reliability Initiative. Getting that more informative picture also helps plant operators rest easier at night, Baird says.

"Having a large number of instruments and valves connected to the HART-based systems for diagnostics can help us achieve a high availability for safety related instruments, critical process instruments and control valves. This gives plant operators the confidence that they have properly operating control equipment."

Thus, an intelligent application of HART technology helps keep the U.K warm. With the predictive diagnostic capabilities built into the system, the Ormen Lange plant should be able to do so in a cost-effective manner for years to come.



2007 HART Plant of the Year

CLARIANT USES HART TECHNOLOGY TO SOLVE MAJOR PRODUCTION PROBLEM

PROJECT OBJECTIVES

- Re-configured field devices from a safe area to adapt to a new production batches.

SOLUTION

- Create a centralized system that would allow access to and modification of the HART devices currently installed in the plant via a Remote Device Management concept
- Centralized access to all devices and centralized the database and management of our instruments.
- HART Communication is used to deliver the process measurement values and device configuration information to a PROFIBUS-Remote-I/O system, which converts the data to cyclic PROFIBUS DP Data.
- The data and device information is viewed daily

RESULTS

- Initial investment cost was low since installed devices were HART-capable
- By saving just 2 or 3 hours of downtime, initial investment could be recovered
- Plant engineers have determined that this project has reduced downtime by at least 60-70%
- Changing device parameters to adjust for a new product is now faster and easier
- Device problems and errors can now be quickly analyzed
- Accessing data from devices in hazardous area is no longer a problem
- Equipment replacement (when necessary) is now faster
- Predictive maintenance alerts enable problems to be detected within seconds and process disruptions to be avoided
- Real-time access to field devices provides assurance that things are working properly

“The return on investment is very high when you use the HART technology that is already in your plant.” Rather than waiting for a “perfect” solution that may require a significant investment, plant managers should look at the technologies they already have for a viable solution to improve operational performance.

The Clariant antioxidants plant in Gersthofen, Germany, solved a major production problem by utilizing the resources already installed in their plant. Clariant uses HART Communication technology in their daily operations to deliver process measurement values and device configuration information to a PROFIBUS remote I/O system, which converts the data to cyclic PROFIBUS DP Data for real-time data access, preventive maintenance and troubleshooting of critical devices located in a hazardous area.

“The return on investment is very high when you use the HART technology that is already in your plant,” says Ludwig Wenninger, Clariant plant engineer. “Going to the device in the field took a lot of time. Now we can access parameters from a central location in a safe area which has reduced the duration of planned shutdowns by at least 60 to 70 percent.”

The Clariant plant produces additives used in plastics production and is responsible for prototyping new



production plants. Because of the numerous chemicals produced, their field devices need to be re-configured frequently to adapt to a new production batch. Many of the devices are located in a hazardous area, which limits accessibility, so a plan was devised to allow access to smart devices from a safe, remote (away from the devices) location.

“To create a centralized system that would allow access to and modification of the HART devices currently installed in the plant, we

decided on a Remote Device Management concept,” says Wenninger. “The system is based on PROFIBUS-Ethernet gateways and uses several automation technologies working together to provide a cost-effective solution.”

Since 1995, the Clariant plant has used numerous HART-enabled devices from multiple suppliers. Because HART technology is defined by a standard specification, all devices were able to be included in the application regardless of supplier, device age or measurement type. HART provides the means of remote device configuration to meet two of the projects main requirements.

Some of the devices were installed in hazardous areas and a notebook PC and other configuration tools could not be used in those areas. Since accessibility and management of the different devices would provide faster process adjustments and possibly provide early notification of pending device problems, the plan needed to provide central access to the intelligent HART devices from a safe, remote location to eliminate the need for routine visits to the hazardous areas.

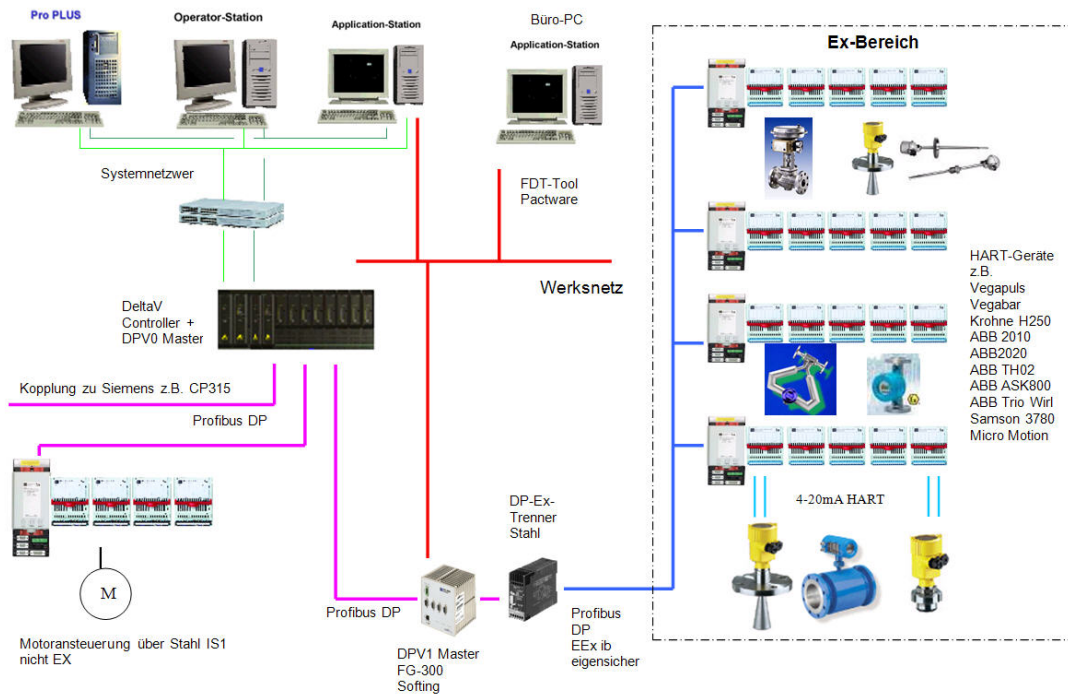

“We wanted to use the possibility of device adjustments and remote configuration which is built into the HART devices,” says Wenninger. “We wanted to centralize access to all devices and to centralize the database and management of our instruments. So, we decided on a structure where the devices and their information were available full-time and would always be connected to the system.”

HART Communication is used to deliver the process measurement values and device configuration information to a PROFIBUS-Remote-I/O system, which converts the data to cyclic PROFIBUS DP Data. The remote I/O from R. Stahl was selected for this application since it is designed as intrinsically safe and can provide access to devices in the hazardous area.

The link to the hazardous area is a RS-485 intrinsically safe option of PROFIBUS, converting to Standard-RS-485 and then to the PROFIBUS Master gateway by Softing and to the Delta V Field Controller supplied by Emerson Process Management.

“The Clariant project is an ideal example of how to use installed HART-smart devices to their maximum potential—in other words, finding better ways to use what you have,” says Ron Helson, HART

Communication Foundation Executive Director. “Real-time integration of HART data with plant control, safety and asset management systems unleashes the Power of HART technology and provides significant benefits in all phases of the plant life cycle.”

The data and device information is viewed daily and has provided several expected and unexpected results.

- Initial investment cost was low since installed devices were HART-capable
- By saving just 2 or 3 hours of downtime, initial investment could be recovered
- Plant engineers have determined that this project has reduced downtime by at least 60-70%
- Changing device parameters to adjust for a new product is now faster and easier
- Device problems and errors can now be quickly analyzed
- Accessing data from devices in hazardous area is no longer a problem
- Equipment replacement (when necessary) is now faster
- Predictive maintenance alerts enable problems to be detected within seconds and process disruptions to be avoided
- Real-time access to field devices provides assurance that things are working properly

Combining HART with other automation solutions delivers real-time benefits to the Clariant plant 24 hours a day, 7 days a week. Re-configuration of the process to include a new product is now much faster and is accomplished with significantly less time, effort and cost. The ability to diagnose the overall plant operation is considerably enhanced. Downtime due to device re-configuration has been greatly reduced and has already provided complete recovery of initial investment.

HART Communication technology is the “right tool” for management of all field devices delivering data to the control system and device monitoring applications. Justifying the cost for the hardware and software needed for this type of project is easy because the installed HART devices can be used.



2004 HART Plant of the Year



BP COOPER RIVER USES HART DIAGNOSTICS TO SAVE ON MAINTENANCE AND INCREASE PRODUCTIVITY

PROJECT OBJECTIVES

- Gain diagnostic data on hundreds of control valves to pinpoint problems during scheduled shutdowns
- Migrate to new technology with minimal production downtime for installation
- Make use of existing wiring and be compatible with existing valves and transmitters

SOLUTION

- A phased upgrade to intelligent valve positioners caused “no major disruptions to the operation”
- A multiplexer was added to send digital HART device data to an asset management system, while also allowing analog signals to pass to the control system.
- To accommodate an older, analog control system, a converter translated digital HART device data where needed between HART-enabled positioners and 4-20mA signals.

RESULTS

- HART-enabled devices provided process, status and diagnostic data to provide actual valve positions, act as control system position switches and eliminate extra field devices and wiring.
- Plant availability has increased to about 96 percent, and site output rose more than 25 percent in part due to the use of HART technology
- Plant personnel need only pull five or six valves during a plant shutdown instead of 35 to 50 to save “hundreds of thousands of dollars per year in maintenance and production costs,” BP reports.

“We are saving hundreds of thousands of dollars per year in maintenance and production costs,” reports a specialist at BP Cooper River, which supplies one-third of the world’s supply of a vital ingredient in

plastics. HART technology improves communication from valves to analog and digital controls as well as maintenance

A. J. Lambert, an instrument and electrical reliability specialist at the BP Cooper River Plant in Wando, South Carolina, sought to balance two important goals: increasing plant availability without incurring



additional maintenance costs. He achieved his goals, thanks to the application of engineering expertise, hard work and HART Communication technology.

The latter, he notes, played a key role. “We know of no other activity that can provide the kind of savings and plant availability that we are achieving using HART diagnostic data. We are saving hundreds of thousands of dollars per year in maintenance and production costs,” he says.

Located approximately 20 miles from Charlestown, the BP Cooper River Plant manufactures purified terephthalic acid (PTA), which is used in making polyesters, plastic bottles, and other items. Thus, while the plant doesn’t make plastic

it does manufacture a vital plastic precursor.

There are two units on the site, one built in 1977 and the other in 1997. Between them they produce over 2.7 billion pounds of PTA annually, the largest amount of the product from any single location in the world. The plant accounts for nearly a third of the total global PTA production, with hundreds of employees and contractors on site. The Cooper River Plant runs 24 hours a day, seven days a week.

However, it doesn’t run all the time. Periodically, BP has a planned shutdown so that needed maintenance can be done. These scheduled shutdowns cost millions of dollars a day per unit. Before 2001, the plant would undergo a shutdown for maintenance purposes every couple of years.

During those times, the plant’s maintenance and engineering staff would pull 35 to 50 control valves out of a total of few hundred in both units. They selected the valves to pull based on various criteria, including past history and an assessment of wear and use from the manufacturing process. They didn’t have specific information pinpointing, which, if any, valves were causing problems.

As part of a plant-wide drive to lower expenses and increase availability, Lambert started looking at items that had the highest maintenance cost. After going over records for the unit built in 1997, Lambert “... identified 50 of the more critical control valves.”

Getting information on the health of those valves could be vital in meeting the overall goals of the Cooper River Plant. That meant intelligence had to be added to the valves, which in turn required the use of new technology. Any upgrade, though, had to meet certain criteria. Migration had to be easy and not interrupt current operations for any significant length of time.

The investment needed to be minor and benefits readily attainable. Those parameters implied that any solution would have to run over existing wiring and be compatible with the mix of valves and transmitters already in place, a combination that varied by plant unit. For instance, at the time the 1997 unit had smart transmitters but no smart positioners and an analog control system. The 1977 unit had a different blend of technologies.

Getting Smart

Around 2000, BP had spent thousands of dollars installing diagnostic software. At the time the project had been justified in order to get information from a single valve. That installation introduced the HART Communication protocol into the plant, and Lambert started looking into getting valve diagnostics from other locations using the HART signal. After a bit of investigation, Lambert and others were convinced that not only could this be done but that it could be done using the wiring already in place.

Therefore, they proposed a HART-centered upgrade, which plant management approved. The project was completed over the next few years without a problem. “The upgrade to intelligent positioners was phased in over time with no major disruptions to the operation,” says Lambert.

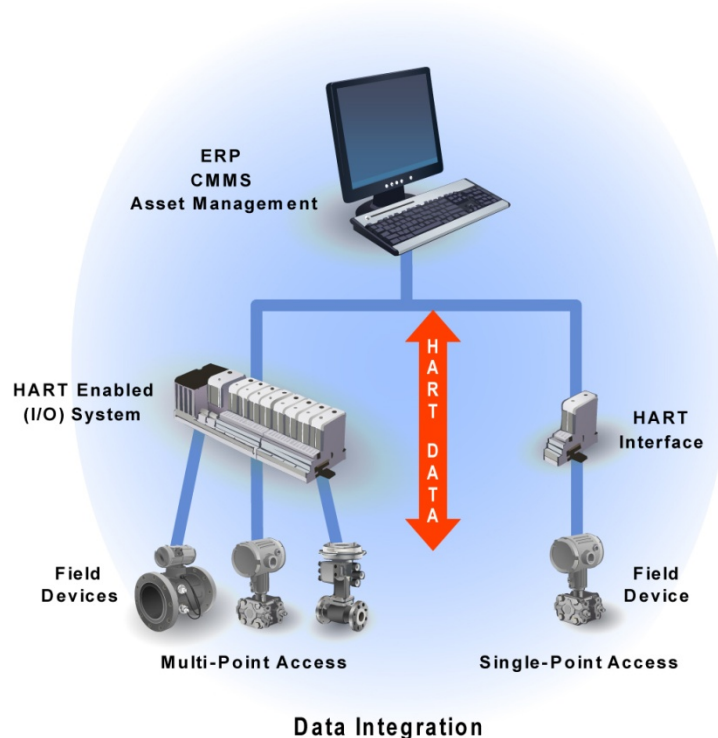

Because of differences between the units, various hurdles had to be overcome. One was the analog control system in the 1997 unit. The BP team solved this through the use of a converter, which transformed digital HART data from the positioner into 4-20mA signals that the analog control system could understand.

That same data, sans conversion, eventually also had to go into an asset management system that would eventually provide intelligence, data for analysis, and other benefits. For that, they used a multiplexer, sending digital data to the asset management system while allowing the analog signal to go to the control system.

Another hurdle involved handling valve position feedback. For that, the Cooper River Plant staff selected interface instruments to extract process, status and diagnostic data from the HART transmitters and valves. These provided actual valve position feedback and acted as position switches for the control system. They also eliminated the need for extra field devices and wiring.

By mid-2004 all of the positioners in the 1997 unit had been upgraded, while 10 percent of those in the 1977 unit were smart. While far from complete, the figure for the older unit includes the most critical control valves. Also at that time, some 150 transmitters and 125 valves were connected to the AMS.

Benefiting from Brains

The payback for this work, notes Lambert, shows up in a number of areas. For one thing, there's been a reduction in valve maintenance costs. Whereas before, some 35 to 50 valves would be pulled during a planned plant shutdown that number has now been cut to only five or six. The maintenance and engineering groups know also why the valves should be yanked out of production before they're pulled. The annual cost savings for this more accurate maintenance is in the hundreds of thousands of dollars.

Through the use of HART monitoring, the plant's staff is able to monitor the health of half a dozen critical valves. They're notified if those valves show signs either of freezing or overheating, allowing preventive measures to be scheduled and taken. This prevents those valves from causing unscheduled shutdowns, which can be very costly.

As a result of the upgrade, plant availability has increased to about 96 percent. One consequence is an increase in output. The installed capacity of the two units was originally 2.2 billion pounds a year. Through these and other improvements, that production has now risen to 2.76 billion pounds a year, an increase of more than 25 percent.

In the future, additional benefits are expected. Plans call for both engineering and operations personnel to begin using the data collected by the smart instrumentation to pin down problems and spot trends. By taking action based on this ongoing analysis, availability should go up and costs come down even more.

So the smart control valves, transmitters and HART Communication have led to both more paper, in the form of monetary savings, and more plastic, due to the increased plant output. The lesson for Lambert is that the payoff of the right solution to a problem could be large. "Get control of the items that touch the product and you can save some big money," he says.



2004 HART Plant of the Year

NEW YORK POWER UTILITY USES HART TO REDUCE COSTS AND IMPROVE RELIABILITY

PROJECT OBJECTIVES

- Monitor and control pressure data
- Enable monitoring of AC power status, which 4-20mA analog wiring could not do
- Reduce costs by eliminating a remote terminal unit (RTU) or programmable logic controller (PLC)

SOLUTION

- Eliminated the need for a mini RTU or PLC at each remote measurement site
- Eliminated the need for as well as an analog modem at each remote measurement site

RESULTS

- Saving approximately \$700 per site
- Facilitates future improvements to reliability, redundancy and regional customer service

Public infrastructure projects are necessary but power utilities face ongoing challenges to provide the most reliable, cost-effective service possible. In keeping with this need, Mark Viglucci at the public power utility of National Grid, Niskayuna, N.Y., used HART technology to reduce costs and improve reliability.

What Needed to Happen

The evolution toward digital communication raised the possibility of finding more cost-effective ways to manage Supervisory Control and Data Acquisition (SCADA) systems than to continue using a traditional 4-20mA remote terminal unit (RTU) or programmable logic controller (PLC) at each remote measurement and control installation. Additionally, Viglucci found that traditional analog wiring could not handle all monitoring jobs needed for SCADA system troubleshooting and field diagnostics.

“Typically these sites have two pressures and one DI alarm for AC power status. Unfortunately, the AC power status can't be monitored,” he said.

The Solution

Viglucci decided to use HART technology in an experiment to eliminate unnecessary hardware in the utility's SCADA system. At two sites, for example, three transmitters were being polled at two different sites by a compact programmable SCADA RTU/controller transmitting data across leased analog data lines.

For signal level and four-wire to two-wire conversion, he designed "a simple interface board containing only four ICs," with the telephone company providing the bridging to allow multiple stations and numerous HART transmitters to be polled (using long-frame addressing), and data to be received in real time.

Benefits and Outcome

The test was a success. Eliminating a controller (RTU or PLC) and analog modem, per-site savings are \$700, according to Viglucci. AC power can now be brought into the maintenance program for greater system reliability. This strategy sets the stage for cumulative savings as sites are added or retrofit, while laying the groundwork for National Grid to make continual improvements in serving its customers.



OHIO STATE UNIVERSITY USES HART TO REDUCE RISK TO PRODUCT

PROJECT OBJECTIVES:

- Improved diagnostics through greater visibility of instrumentation and process
- Improve consistency of process performance with more efficient maintenance
- Speed troubleshooting and corrective maintenance for greater process consistency
- Better manage instrument configurations to reduce risk

SOLUTION:

- Installed approximately 250 HART-based devices, with automatic loading of tags and operating information by a HART-enabled DCS
- Integration with DCS asset management software

RESULTS:

- Saved a potential \$300,000 (USD) superheater replacement by using HART data to convince vendor to instead address faulty valve controls
- Enhanced maintenance responsiveness with context-specific notifications such as “primary variable (PV) was out of sensor limits” or “bad: check measuring”
- Protected process integrity by validating analog readings with digital HART data to trigger events and investigation of discrepancies
- Broadened quality assurance through tracking of PV drift using PV validation (above)
- Enabled increased fault monitoring using automatic redundant formats

The Ohio State University’s McCracken power plant provides 85% of the campus’ steam-based energy. “Without HART, this plant wouldn’t operate,” says Jerry Lowery, control systems engineer. Better data visibility helped to ensure process consistency and instrument reliability for greater productivity and better maintenance.

“Being able to effectively manage our instrument configurations reduces our regulatory risk and our risk to product,” says Jerry Lowery of The Ohio State University (USA) as he attests to the essential value of HART Communication in industrial automation applications. One benefit he names is that most technicians are familiar with HART-enabled communicators.

“The technicians just love them. They’re superior for the technicians,” he says. Another important feature for Lowery, who is a control systems engineer for the university’s McCracken power plant, is that HART is an open standard. “It gives everyone a common thing to work toward. HART is the way to go. It makes life so much easier.”

Operating continuously, the McCracken plant provides 85% of the Buckeye campus’ steam-based energy needs. The steam is used for heating, humidification, sterilization, chilled-water, and domestic hot-water production.

The plant has five industrial boilers, a Babcock & Wilcox D-Style, 600-psi, 220,000 lbs/hr unit, and four 200-psi Nebraska D-style units that produce 150,000 lb/hr of steam. Co-located at the plant are ten York chillers producing 16,000 TR/hr, and three Caterpillar emergency diesel generators with a rated total of 6,300 kWh.

Lowery doesn’t mince words about how important HART technology is to the plant. “We have approximately 250 HART-enabled devices. Without HART, this plant wouldn’t operate,” he says. HART also helps the plant’s technicians save time finding instrument problems. “We don’t have to spend as much time looking for what’s wrong,” Lowery adds.

In one instance, staffers observed intermittent signal failures on a temperature transmitter on one boiler’s superheater (SH) vent control, which caused the vent to go into the wrong position. However, thanks to a HART-enabled DCS system on the Nebraska boiler, they were able to quickly correct the problem.

Intermittent signal failures are some of the more difficult field problems to diagnose as the problem may only happen occasionally for no apparent reason. “Before having continuous HART monitoring of devices, we would have to guess at the problem if it wasn’t apparent and start replacing items (sensor, transmitter, or analog input) to see if the problem would go away, says Lowery. “With HART and the ability to continuously monitor the HART signal from the device, we are able to log the issue in the DCS/Asset Management software and go out and correct the actual problem.

“We have two quad operator stations with four human-machine interface (HMI) screens and four others where HART data appears via the DCS,” he explains. “This was the first time we’d seen this type of HART information.”

The displayed spreadsheet showed data which has a log/time-stamp describing an event. In this case, descriptions included “primary variable (PV) was out of sensor limits” or “bad: check measuring” and “field device malfunction.”

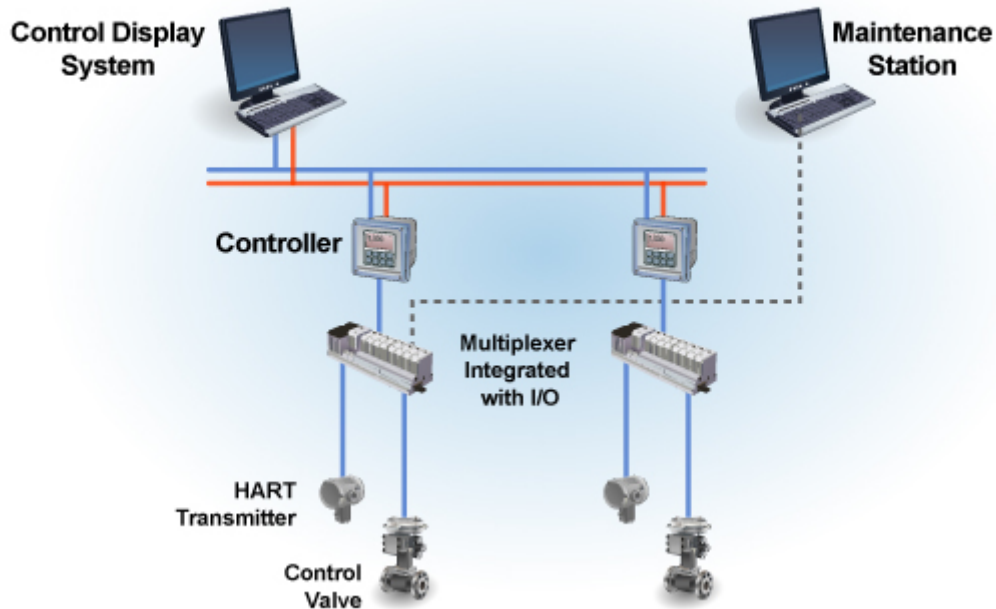

Once the staff learned of the event descriptions in the event log, they were able to solve their problem the same day. “We knew exactly what was wrong. The technician went out and repaired the resistance temperature device (RTD),” Lowery says, adding that with their HART-enabled DCS, “our technicians know exactly what the problem is.”

Results Proven, Risks Lessened

A second occurrence at Ohio State involved a Superheater (SH) vent-control valves failure. The boiler superheater vent valve wouldn’t open or would become stuck while partially open, Lowery recalls. “A vent-control valve failure put the boiler superheater at risk.”

Lowery’s solution was to use the HART Protocol’s digital PV (DigPV) that was accessible from the DCS. He used the valve positioner digital PV to validate the valve’s position. He says if the valve didn’t reach proper position within 30 seconds, an alarm would sound and a warning would simultaneously be displayed on the HMI screen.

The DigPV, which proved that the valve was not seating properly, and the digital secondary variable (DigSV), in this case positioner temperature, indicated that a temperature “over range” had occurred.

“The HART secondary value or device temperature on the original positioner was trended and used to prove that the device had never exceeded its maximum operating temperature of 50 °C,” says Lowery.

The data convinced the vendor to replace the valve positioner, “and the problem went away.” This is important because the vendor originally claimed the boiler’s operation had overheated and caused the SH vent-control valve to become stuck.

Armed with their HART-enabled DCS evidence, Ohio State got the vendor to fix six SH vent valves saving approximately \$10,000 (USD). Also, the combined digital PVs' and SVs' performance not only saved a potential \$300,000 (USD) cost of replacing the existing superheater, but also led the vendor to install a more reliable positioner.

Lowery appreciates this digital value functionality. "Digital PVs are extremely valuable in critical loops to validate the analog position with the digital position," he says. In addition to diagnostics, having both analog and digital communication available simultaneously with HART is of particular value to Lowery.

"This capability is extremely important when validating loops. We use the digital PVs to validate analog PVs on critical positioners. It just tells us what is wrong with the device," he states. "And on critical loops, if the analog PVs and digital PVs don't match up within a certain percentage of each other, we alarm that loop and have operators investigate the actual valve position."



The simultaneous analog-digital capability of HART fulfills one of the most obvious asset management functions of HART-enabled automation—protecting equipment and keeping plants operating.

Of the 250 HART-enabled devices at the McCracken plant, an asset management system (AMS) monitors 188-200 of them. With a separate server, the AMS has a processor and input/output (I/O) modules. "The asset manager monitors and tracks device faults for all HART-enabled devices. Types of device faults — anything you can think of," he says.

Overall, diagnostics are much improved. "Our asset manager package tracks faults that occur in HART devices through our DCS. Small items, like a positioner losing its zero position, are now caught early and repaired," Lowery says. "But without that asset management software, the problem might have never been corrected because it wouldn't have been seen until complete device failure."

Correct monitoring, particularly with HART-enabled instruments, also concerns Lowery, who offers tips for users. “HART device diagnostics is only as good as the vendor’s device description (DD) file. The more detailed the DD file, the more diagnostics you’ll have.”

Lowery also suggests insuring that the DCS analog I/O is HART-enabled. “Using a third-party solution to strip out and send HART data via a serial connection will likely prevent using HART digital PVs in a fast changing loop,” he says. *Caveat emptor* (Let the buyer beware!) is his advice regarding proprietary functions in HART devices.

“Some vendors tweak a HART DD file to their advantage, so you’ll use their DCS with their HART devices,” Lowery says. He advises users to make sure all functions are accessible.

“Check that the DD file registered at the HART Communication Foundation is the file that the vendor distributes. Also, consider joining the Foundation. DD files from the Foundation are tested to be sure they are compliant to the standards.”

Ohio State’s experience with HART was so positive that, according to Lowery, the university has only scratched the surface of using the protocol. For quality assurance, the power plant’s staff is examining tracking the drift of the analog PV compared to the digital PV. Also, there’ll be more use of HART device diagnostic faults in the control strategy. Adding this tracking ensures agreement between the digital PV and analog PV readings.

Ohio State also plans to evaluate using a field device manager (FDM) for configuring HART devices, rather than using HART communicators. How will that affect operations? “It will help us catalog devices. We’re told that if you replace a device, when you plug it in, the DCS will automatically load its tag and other operating information,” Lowery says.

Finally, through its asset manager, the university will increase fault modeling at McCracken. What part will HART play? “All HART devices can tell you if there’s a fault,” Lowery says. “We can go to redundant format automatically.” That’s important, he notes, because the analog PV value could be in error.

APPLETON PAPER USES HART TO IMPROVE ASSET MANAGEMENT AND SAVES \$40,000 ON WIRING ALONE

PROJECT OBJECTIVES

- Minimize costs for hardware, software, training, spare parts, etc.
- Find a simple, robust system to inform staff about the device health and use that system in other applications.
- Get a database for configuration, tracking, troubleshooting, etc.
- Obtain access to all instrument/device data.

SOLUTION

- Integrate HART Communication with distributed control system (DCS).
- Install more than 100 HART-enabled flowmeters, control valves and pressure sensors throughout the facility.

RESULTS

- Improved instrument configuration and preventive maintenance capabilities
- Lowered operation and maintenance costs
- Accessed multivariable mass flow information
- Realized enhanced device diagnostics
- Improved control-loop validation
- Increased plant availability
- Enhanced regulatory compliance
- Achieved higher product quality and product yield

Pulp-and-paper producer Appleton Paper used HART technology in a major upgrade of their paper-coating operation as the catalyst for improving asset management. The company installed more than 100 HART-enabled flowmeters, control valves and pressure sensors at its facility in Appleton, Wisconsin, with positive results.

“HART gave us the best opportunity to expand with the rest of our existing control systems at the lowest costs,” says Chris Van Sambeek, Appleton control systems technician.

The papermaker targeted several criteria for the project: minimize costs for hardware, software, training, spare parts, etc.; find a simple, robust system to inform staff about the device health; use that system in other applications; get a database for configuration, tracking, troubleshooting, etc.; and obtain access to all instrument/device data.

Appleton uses HART Communication via a PLC and a HART-enabled I/O system to link the smart instruments to an asset management system. With the enhanced troubleshooting capability that HART technology provides, Appleton has improved its instrument configuration and preventive maintenance capabilities.

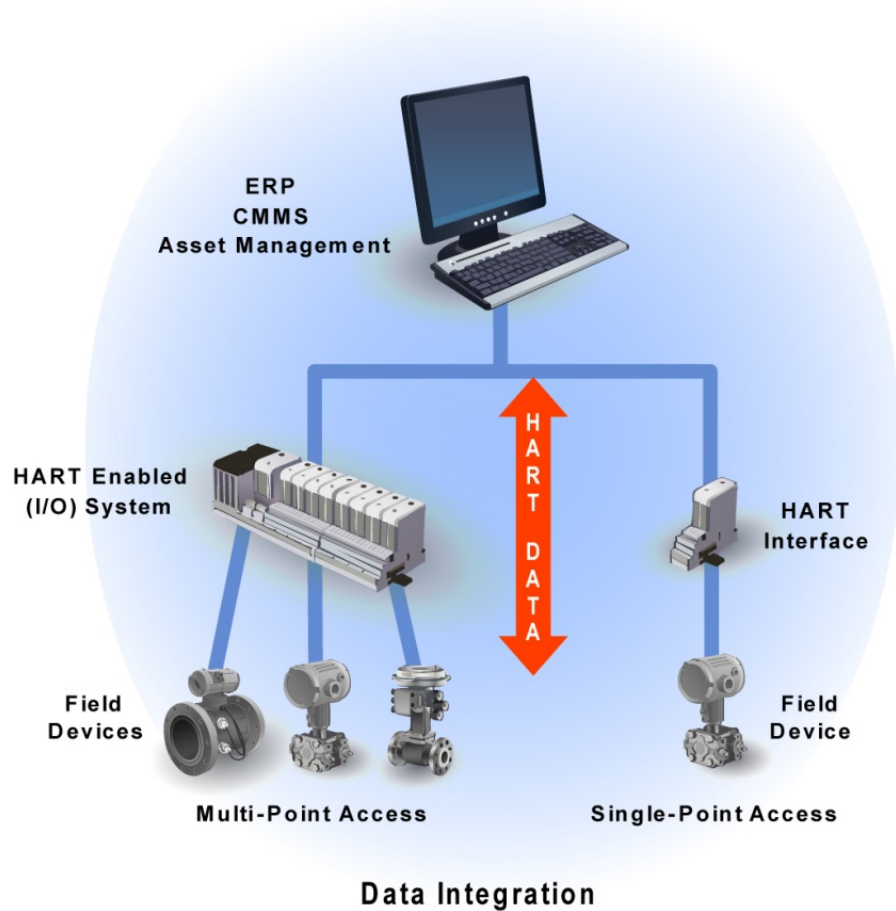

“HART technology saved us roughly \$40,000 on wiring alone with its ability to pull multivariable information from our mass flowmeters,” says Sambeek. Appleton has also saved time and money by

remotely configuring devices. HART technology saved the company another \$10,000 because they now need 12 fewer pressure and 12 fewer temperature transmitters.

Sambeek says HART also improved operations in other areas including “better diagnostics; control-loop validation by pulling information into the PLC through the HART signal; increased plant availability; better product quality and utility; higher product yield; lower operations and maintenance costs; and enhanced regulatory compliance.”

Finding a new HART smart card that the PLC system could use also helped Appleton. This card allowed the company to upgrade existing systems with minimal equipment and costs, says Sambeek. “Most of our existing instruments are HART-enabled, and the HART cards used are compatible with our existing control systems.”

Installing an OEM’s HART-enabled cards into the control PLC platform allowed Appleton to use HART data in both the asset management and control systems. “HART provides additional information not available to normal analog systems,” Sambeek adds.

“HART has been very effective,” says Sambeek. “We succeeded because the HART Protocol is a better fit for expansion than other fieldbus technologies.”

FRASER PAPERS GAINS PREDICTIVE MAINTENANCE EDGE USING HART VALVE POSITIONING

PROJECT OBJECTIVES

- Connect HART-enabled valve positioners to a single central computer
- Integrate the newly accessible control valve position data into a predictive maintenance program

SOLUTION

- HART-based positioners were linked to a multiplexer using a HART-enabled interface module with additional hardware and software
- Import and archive critical data such as valve signatures and operational data
- Operational and diagnostic data coming through the multiplexer were presented to control as well as device-managing system software

RESULTS

- The maintenance system provided critical benefits in diagnosing problems during outages as well as ongoing preventive maintenance benefits
- By avoiding direct PC and handheld calibrator contact at the field level, HART technology reduced the risk of creating an upset to the process, and also reduced maintenance man-hours
- Using HART Communication and interfacing digital valve positioner data using a multiplexer allows a Canadian paper mill to increase efficiency, improve data retrieval and perform continuous remote diagnostics.

Many end users have realized the benefits of installing HART-based control valve positioners and using HART technology to integrate the positioners with their central computer system. Fraser Papers, a division of Thurso in Quebec, Canada, standardized its paper mill on HART-based positioners as the first step in a proactive maintenance program.

In June of 2000, the mill wanted to connect all of its HART-based positioners to one central computer. An integration package consisting of digital products and software solutions allowed the mill to realize the full benefit of their HART Communication investment.

The solution was to link all HART-enabled positioners to a multiplexer (MUX) using a HART-based interface module in addition to other hardware and software components. The MUX allows the facility to use computer software to oversee all of its digital positioners in the mill and link the information in an effective device management system.

Fraser Papers began to realize significant benefits soon after implementing the HART-enabled device management system, including increased efficiency, easier retrieval of information and continuous remote diagnostics.

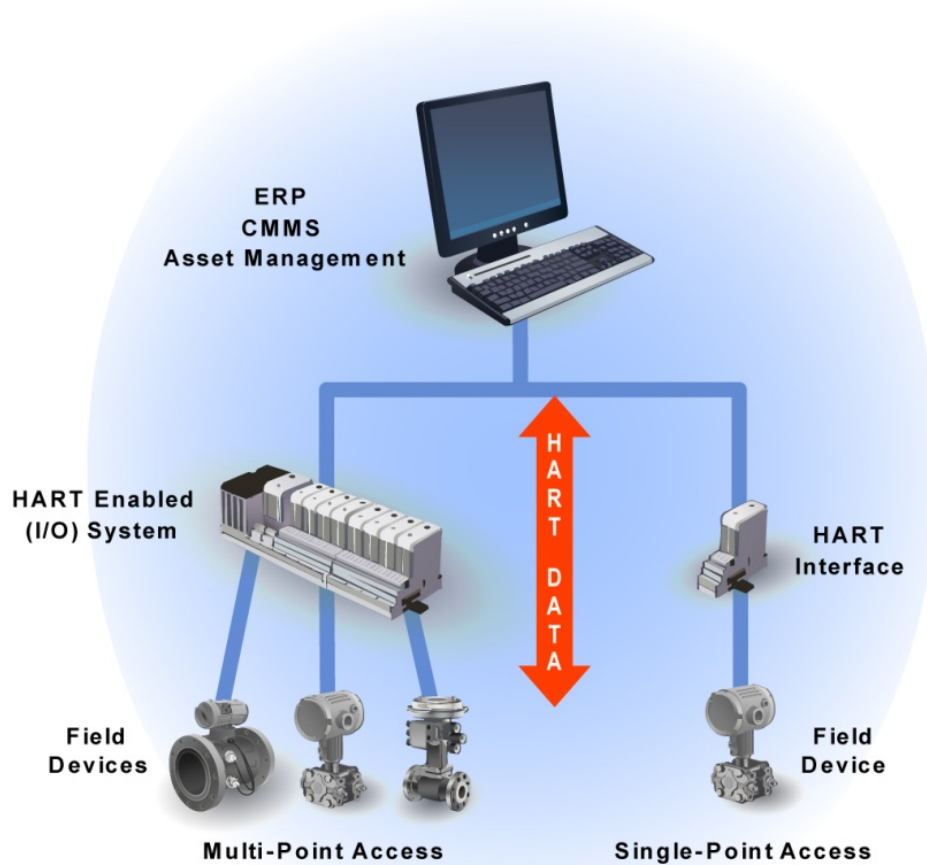

Data Integration

“With this system in place, our maintenance technicians can quickly access the device to calibrate and create electronic maintenance records,” says Mario Leclerc, Fraser Papers instrumentation engineer. “This reduces the risk of creating an upset to the process by avoiding a PC or handheld calibrator connection to the loop terminals. It also helps us manage man-hours more efficiently.”

Archiving information (such as valve signatures and continuous operational diagnostics) in maintenance records allows technicians and maintenance engineers to implement a program of preventive maintenance on control valves in various sectors of the mill during outages.

Using the dial-up modem or through the Ethernet, personnel can remotely troubleshoot valves or request remote assistance from the positioner manufacturer. This helps determine whether to pull the valve out or simply do minor corrections. The maintenance software can generate step tests of varying amplitudes, making it easy to validate valve responsiveness online.

Using the online diagnostic capabilities of the positioners, the MUX is able to acquire information seamlessly. This, in turn, simplifies the implementation of a preventive maintenance program, based on recorded mean-time-between-failures. These continuous diagnostic values allow the user to determine if the valve selected is adequate for the service. They can also determine premature trim wear, using the time-near-closed counter.

HART-based technology has opened new doors to help run plants with less downtime while providing a mechanism to transport critical information from field devices over existing field wiring. The implementation of a HART system similar to that installed at Fraser Papers is the key element in implementing a predictive and preventive maintenance program.

SWEDISH PULP AND PAPER PLANT USES HART TECHNOLOGY TO IMPROVE PLANT AVAILABILITY

PROJECT OBJECTIVES

- More efficient, effective calibration of field devices
- Higher data availability without the up-front investment in digital field networks.

SOLUTION

- Enhanced connectivity from control room to instruments
- HART-enabled devices can be installed anywhere on the 4-20mA control loop.

RESULTS

- HART technology eliminated a 30-minute trip to the field for any given device.
- Calibration now done from the safety and comfort of the control room.

HART technology saves trips to the field for improved plant availability. That's what user Jimmy Andersson, found when he upgraded existing control loops with HART protocol-compliant instrumentation at a pulp and paper plant operated by Vallviks Bruk AB in Söderhamn, Sweden.

As with many users, the Swedish plant needed a way to upgrade its 4-20mA analog wiring without the expenditure in full digital field networks. Without effective calibration and data access, plant operations, asset availability and quality compliance suffer.

The Solution

Handheld or PC-based HART-enabled devices/applications that can be installed anywhere on the 4-20mA control loop help Andersson save time and reduce costs. "Now I don't have to go out in the field to check if a specific instrument is 'alive'," he says. A trip to the field averages about 30 minutes per device. Multiplying the number of devices accordingly multiplies the savings.

Benefits and Outcome

According to Andersson, HART technology improves operations, specifically enhancing plant availability and quality compliance. “The greatest benefit is that I can calibrate instruments from inside the control room,” he says, which is “a lot safer and more comfortable than doing it out in the field.”

HART Communication has reduced configuration and set-up time as well. “Before HART we had to calibrate the instruments out in the process. Now we can do it right where the signal goes into the control system,” Andersson says. After initial implementations, the plant's plans with HART technology expanded to the start-up of a new turbine.

According to Andersson, using HART technology for data including instrument calibration has improved the performance of controls for improved plant operations, asset availability and quality.

BRAZILIAN STEEL PLANT USES HART COMMUNICATION TO REDUCE DATA RETRIEVAL TIME

PROJECT OBJECTIVES

- Faster, more complete access to data
- More data visibility for process management and instrument maintenance
- A cost-effective solution for an existing plant

SOLUTION

- HART-enabled control, software and asset management systems
- Handheld communications devices (Models 275 and 375).
- PC Anywhere for remote off-site access.

RESULTS

- More data available to personnel on off-hours—including technicians at home—to assist at-plant personnel as needed.
- Time and money savings through faster configuration and modifications.
- Changing a range in a traditional analog setting once took an hour; it now takes five minutes with HART technology.

HART technology helped engineers and technicians at a COSIPA plant in Sao Paulo, Brazil, more effectively configure and access data to better manage field devices across the automation network. In fact, some tasks that once took an hour to complete now take five minutes.

What Was Needed

Personnel at this existing plant needed faster data access for process management and instrument maintenance.

The Solution

HART-enabled process control and asset management systems plus handheld communications devices (Models 275 and 375).

Benefits and Outcome

To calculate the cost savings in time and money realized by the COSIPA plant, we must first note that in Brazil a technician earns the equivalent of \$10 USD per hour. Using HART Communication saves the plant about one hour on each device and there are 200 devices in the plant.

According to user Marcos Martins, when with traditional 4-20mA wiring, “I spent one hour just to change a range. I spend five minutes to do this same task with AMS.” Equipped with HART Communication, the asset management system provides the user with instant visibility.

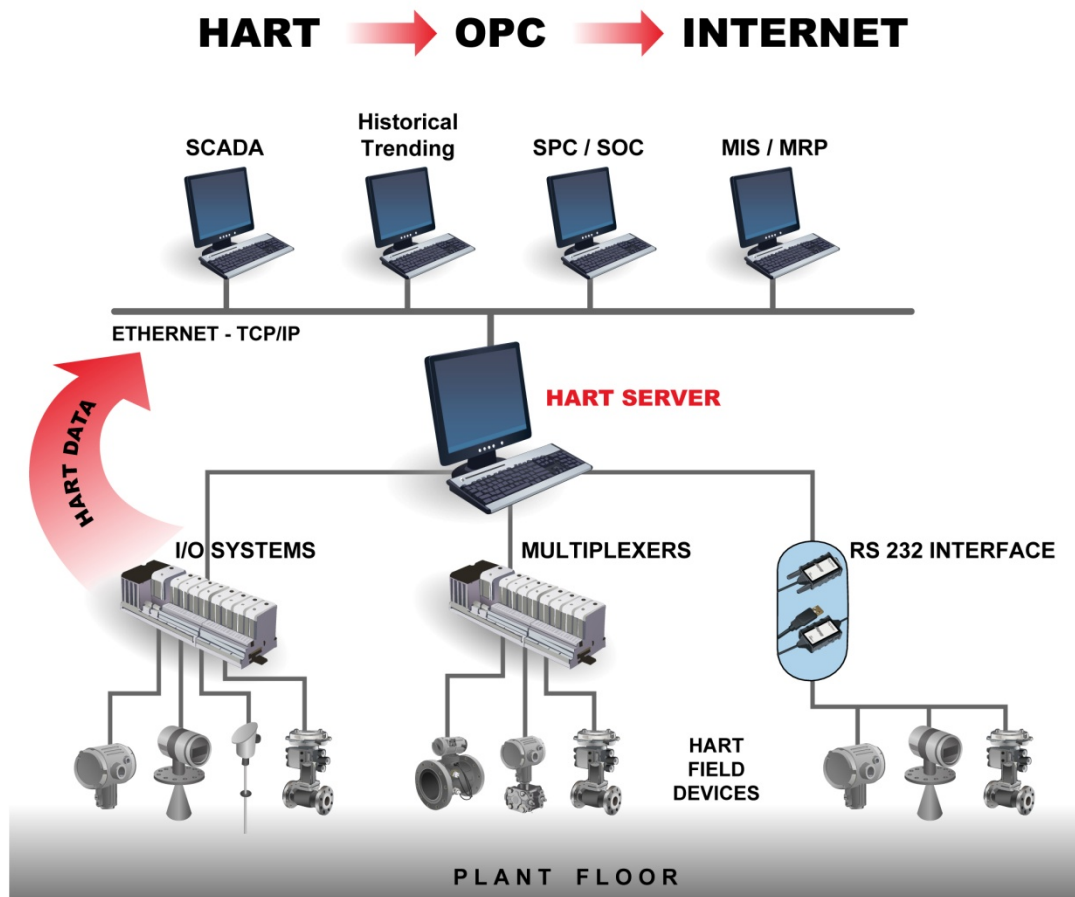

Eliminating trips to the field has significantly sped setup time for Martins' technical team. Instead of traveling to a device in the field, opening it and working with configuration tools there before heading back to the workshop, a technician can cut an hour down to 20 minutes using the HART-enabled asset management system without leaving the workshop.

HART information, of course, travels wherever the network takes it. Martin says, "With PC Anywhere and the asset management system, I can work from my house to see the diagnostics, configuration and process variables at the plant, 24/7." The same goes for all plant personnel off their shift, who might be called upon to solve problems on an ad-hoc basis.



AECOM CANADA USES HART COMMUNICATION TO KEEP WATERWAYS CLEAN

PROJECT OBJECTIVES

- Prevent unplanned discharges of sewage to keep waterways clean
- Avoid fines that result from tightening regulations
- Find the most cost-effective and accurate system so the system can be widely replicated.

SOLUTION

- HART-enabled remote terminal unit and instrumentation at each site
- HART communications card and IP-addressable Ethernet data radio at each site for remote access
- Standard single-wire, single-bus connection for a faster, more accurate multi-variable data path to magnetic flowmeters and pressure transmitters

RESULTS

- Full access to multiple variables from field instruments on a single wire.
- Significant time savings over the use of separate 4-20mA wiring.
- A reliable defense against potential 100s of thousands in regulatory fines.
- Future-proofing: Engineers can change their control strategy without running new wires or re-wiring their systems.
- With *WirelessHART* technology solutions now shipping, future installations will reap additional savings by eliminating physical wiring labor, time and cost.

Few cities use modern technology to monitor and detect leaks, particularly as sewerage travels across waterways. Facing tightening environmental and regulatory requirements, AECOM Canada, Ltd., in Winnipeg, Manitoba, designed and created first-case system using HART Technology to address the issue.

To prevent unplanned discharges—leaks—in its sewage system, particularly at river crossings, one city in Manitoba, Canada, called upon engineering firm AECOM Canada, Ltd., Winnipeg, to design and test a first-of-a-kind monitoring and detection system. HART technology proved critical in speeding implementation and providing the flexibility to reconfigure the system without the time or expense of physical rewiring,

The particular challenge was to monitor force-main sewer lines at river crossings, where gravity cannot lift material through lines and low-pressure pumping (10 to 15 psi) is a common solution. Despite tightening environmental regulations, engineers could find no existing solutions. Most cities rely on visual inspection—a poor substitute for technology because contamination can leak for weeks before a problem is detected, damaging waterways and drawing regulatory fines.

Unfortunately, "very few" cities have applied modern monitoring solutions because, says AECOM's Kent McKean, senior automation designer, and a viable commercial solution couldn't be found.

The Solution

McKean's team used a basic architecture involving instrumentation connected to a remote terminal unit (RTU). The RTU was equipped with an IP-addressable Ethernet data radio at each site to remotely access site data and a HART communications card.

McKean and team decided that for test installations, they would specify a system that would "give us flexibility, perhaps more flexibility than what we actually needed" because there was no way to "definitively predict" which system design would work best.

In mid-2007, the first test installation went online using magnetic flowmeters sending data to the RTU to be totalized and compared with data points coming in eight- to 10-hour increments. The HART protocol would prove its value in providing that flexibility when McKean's team decided on a "change in philosophy" that would require reconfiguring the system to provide instantaneous, real-time data in addition to the existing totalization strategy.

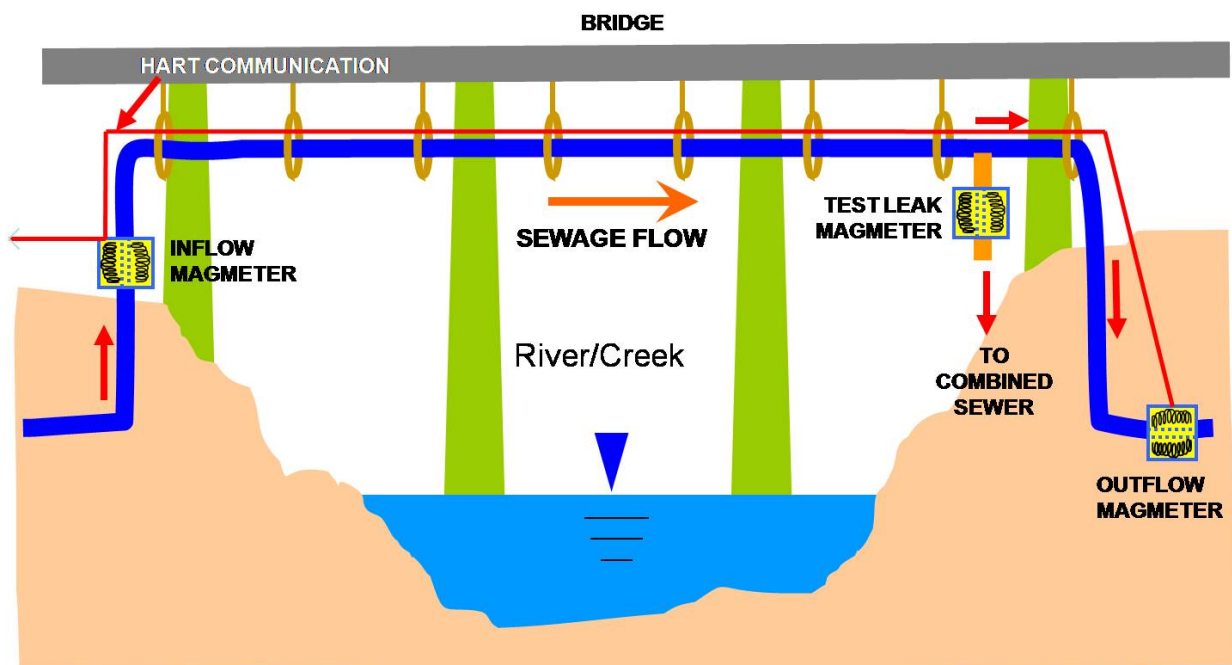

This change "was easily accomplished because we had selected HART," says McKean. Instead rewiring and reconfigure physical equipment, he says, "HART technology and the system's software put all of the variables we needed at our fingertips." The change in data handling led to an increase in resolution from 10 to 15 liters per second, to one or two liters per second.

Late in the summer of 2008, the AECOM team installed a second test-site system using the same strategy but switching from flowmeters to smaller, easier-to-install pressure transmitters measuring the pressure inside and also in the interstitial space. This enabled users to pinpoint the location of a leak as well as its failure mode, such as whether the exterior or interior pipe has failed. This solution was less intrusive and provided easier, safer access; reduced maintenance trips by several hours; and slashed system cost from roughly \$500,000 to between \$30,000 and \$50,000 per crossing, according to McKean.

Benefits and Outcomes

HART technology provided "much higher accuracy and resolution" than 4-20mA analog wiring while requiring no hardware and only minor software changes to accommodate the upgrade from totalization to instantaneous data monitoring. The same benefits can, in turn, reduce the cost of future upgrades. "If we had gone with a non-HART solution or a non-data bus solution, we would have been very limited in the data that we could have gotten," McKean says. "We would have had to use a separate radio or data channel for each variable that we *may* need, or we would have had to change things on the fly as we were developing."

"If we were to implement this system today, we would utilize *WirelessHART*," McKean says.



DETROIT WATER DEPLOYS HART TO IMPROVE CUSTOMER SATISFACTION

PROJECT OBJECTIVES

- Redundant metering systems would register different volumes, which led to billing disputes.

SOLUTION

- Modernize and unifying the point of sale metering system and transmit the data in real-time to DWSD and every wholesale customer.
- Use existing analog instrumentation and the skill set of our technicians while providing us the benefits of a state-of-the-art digital and paperless metering system.
- Distribute the totalization function to a lower, HART-enabled smart device level, instead of the traditional PLC/RTU device.

RESULTS

- Complaints about low water pressure have been virtually eliminated since a majority of these complaints have been attributed to faulty regulating valves operated by our wholesale customers.
- Safety has also been improved since the need to enter the OSHA regulated confined space of the underground metering facilities for troubleshooting purposes has been greatly reduced or eliminated..
- Metering data obtained from the HART-instrument is communicated and stored in digital form, eliminating paper-based recordings.
- A digital packet radio network, which functions like a wireless intranet, is used to “carbon copy” all metering data to redundant data historians and to SCADA PCs that DWSD provided to each customer.

The need for having redundant metering systems has been eliminated since the same metering data reported from our HART-based instruments to the RTU, is “carbon copied” every five minutes directly

from the on-site RTU to DWSD as well as to our wholesale customers within a few seconds – we provided a SCADA PC to each wholesale customer. This has already contributed to improved customer satisfaction.

“HART has served us so well by utilizing all of our existing plant assets.”

*By Dennis L. Green, P.E.
Head Water Systems Engineer
Detroit Water and Sewerage Department (DWSD)*

The Detroit Water & Sewerage Department (DWSD) is the third largest water and wastewater utility in the United States. DWSD provides services to nearly 1 million Detroit residents and, on a wholesale basis, to over 3 million suburbanites living in the surrounding areas.

To determine water consumption at the point-of-sale, we had installed metering systems. Our point-of-sale metering systems included a variety of traditional instruments such as mechanical meters, venturis, orifice systems, magnetic flowmeters and chart recorders. Likewise, our wholesale customers had installed their own point of purchase metering systems, acting in parallel, to make their own measurements. Very often, the redundant metering systems would register different volumes, which led to billing disputes.

The solution was modernizing and unifying the point of sale metering system and transmitting the data in real-time to DWSD and every wholesale customer. An essential and critical part of the multi-million dollar modernization project was implementing an automatic meter reading/supervisory control and data acquisition (AMR/SCADA) system that relies on the HART global standard to deliver consistent, reliable data on system performance.

The innovative application of HART technology enabled us to use existing analog instrumentation and skills set of our technicians while providing us the benefits of a state-of-the-art digital and paperless metering system.

Today, the HART standard based digital metering system has not only improved the reliability of our water metering operations but has also provided our customers with greater satisfaction by virtually eliminating billing disputes caused by metering problems. As a bonus, our new HART based smart instruments also provide additional flexibility to make on-line configuration changes including calibration, perform calculations and support real-time remote diagnostics.

DWSD Services

With an operating budget of over \$350 million, DWSDs' services extend well beyond the Detroit city limits to an 8-county area of more than 1,000 square miles including approximately 43% of Michigan's population. DWSD, which is a branch of the City of Detroit government, employs about 3,200 persons and has the fifth lowest combined water and sewerage rates per month amongst the 20 most populated

cities in the United States. DWSD operates five water treatment plants pumping an average of 655 million gallons of clean drinking water each day, peaking at 1.5 billion gallons per day.

DWSD serves about 90 wholesale customers representing about 137 suburban communities via nearly 300 underground metering facilities. Figure 1 illustrates one such underground metering facility. These metering facilities typically include flow and pressure measuring instruments, valves and actuators to monitor and control the flow of water to the wholesale customer.

Akin to custody transfer stations, these metering systems, which include approximately 750 smart instruments, provide valuable inputs to detect and compute water usage, and hence billable sale to each wholesale customer. Since the metering systems are critical for billing purposes, we often refer to the meters as our point-of-sale “cash registers”.

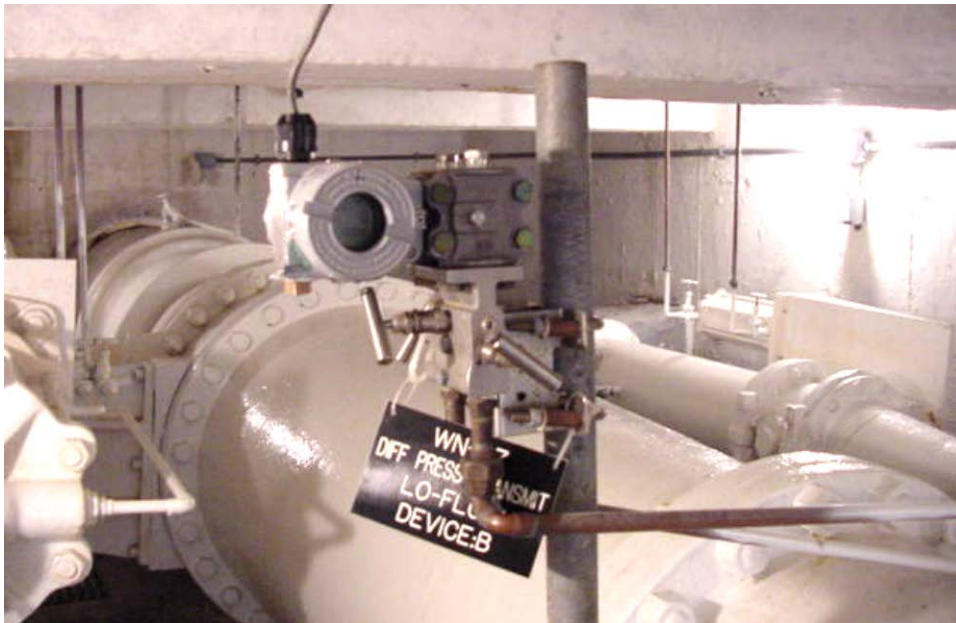

Figure 1. Typical underground metering facility

Need For a New Metering System

Prior to implementation of the AMR/SCADA project, the metering facilities included a variety of traditional instruments such as mechanical meters, venturis, orifice systems, differential pressure transmitters, sonic meters, magnetic flowmeters and chart recorders. The existing metering facilities used no electronics with the mechanical meters, and all other instruments used chart recorders and mechanical pulse totalizers.

Thus, recording of all metering data was paper-based and collected manually bi-monthly or weekly by human meter readers. Various instrumentation companies including Smar, Endress+Hauser, and ABB manufactured these instruments.

By the mid-1990s, however, many of our wholesale customers had concerns over their water consumption data. They elected to install their own point-of-purchase “cash registers” to collect more frequent readings and validate their DWSD water bills. The point-of-purchase “cash registers” included redundant metering systems measuring the same water flow and pressure as DWSD recorded on our paper chart recorders. Quite often, the two metering systems disagreed over the water consumption data.

Moreover, the resolution of the chart records was insufficient to prove one party’s assertions over the other, the simple odometer-type totalizers provided no profiles of the consumption data between visits by our meter readers, and all humans make occasional mistakes when recording data. The disagreements over a mutually acceptable set of measurements resulted in billing disputes, customer dissatisfaction and loss of thousands of dollars in revenues.

Acquiring Leading Edge Technology to Improve Customer Satisfaction

DWSD decided it must modernize and unify the point-of-sale metering system and improve customer satisfaction. Our goal was to eliminate dispute-causing devices such as chart recorders and mechanical totalizers and replace them with a digital and paperless metering system specifically to:

- 1) Improve dependability, accuracy and confidence in the metering data by recording meter readings every 5 minutes – Objectives were ending the practice of our wholesale customers installing their own redundant metering equipment that often disagreed with DWSD’s, leading to billing disputes. Failure of any single component of the system must not disrupt system performance, any recording of data, or any calibration work of the meter technicians – excepting the one failed meter register.
- 2) Preserve metering data integrity – Data consistency must be maintained throughout the system. The same consumption data must be concurrently provided to DWSD as well as each wholesale customer. In addition, there must be opportunities to recover data when failures occur.
- 3) Archive 10-years of meter data in redundant historian systems for efficient storage and retrieval, engineering analysis and process improvement.
- 4) Provide an intuitive, easy-to-use, user interface to assist our staff in the setup and calibration of the meters while automatically documenting the data for certification of our “cash register” - the billing meter. Minimal reliance on paperwork to share information throughout the system by storing the calibration reports in the database of the AMR/SCADA historian.
- 5) Reduce operating costs of the Meter Operations Division by standardizing on the equipment used and by controlling software revisions.

To get the maximum out of the investment in the meters, they are usually sized for predicted future consumption that may or may not develop. By using peak hourly consumption data, rather than maximum meter capacity, a more equitable rate formula can be established based on peak consumption. In addition, the range of the instruments can be set based on actual peak demands to improve the accuracy of the instruments as the technicians have a basis for making their range adjustments as consumption increases or declines over the years.

DWSD is owned and operated by The City of Detroit and has had to resist frequent regionalization attempts by some of its suburban customers. Being a rate funded utility and having to defend those rates annually, the project risk and overall installed costs were of paramount importance to our management. Any proposed solution incorporating the latest and greatest technology had to address risks and costs satisfactorily and, in addition, had to address the risk of failure. That is, a backup plan had to be developed and approved by our management in case the proposed solution did not function as planned.

Demand Based Rate Model

In addition to the above described project objectives, Stephen Gordon, former director of DWSD, had expressed a desire to use the modernization project for restoring DWSD's traditional position as an industry leader. His vision was to introduce a demand based water usage rate model in the water utility industry. More specifically, he wanted a system that would support the development of a demand based rate model, similar to the model(s) used by the electric utility industry, where there is an infrastructure charge based on peak load and a consumption charge for total usage. This requirement implied that the new metering system was capable of performing and preserving multiple reads every hour to identify the peak hourly demand.

Developing a New AMR/SCADA System by Leveraging HART Technology

Before launching the project to modernize the point-of-sale metering system, we had recognized the ability to calibrate instruments remotely and on-line as an important function to improve reliability and confidence of metering data. By 1996, we were well underway to implement an instrument upgrade project to incorporate the HART standard into many of our existing 4-20mA instruments. The HART based smart instruments would facilitate calibration and at the same time preserve our investment.

During 1996-97, DWSD developed and implemented a pilot-scale version of the AMR/SCADA system to modernize the point-of-sale metering system. The pilot project was expanded (1999-2002) to a \$10 million major infrastructure upgrade. Figure 2 illustrates a schematic diagram of DWSD's AMR/SCADA system. The AMR/SCADA system utilizes a packet radio network of personal computers, programmable logic controllers (PLCs), and remote terminal units (RTUs). The system relies on the power of HART communication to deliver consistent, reliable data on system performance.

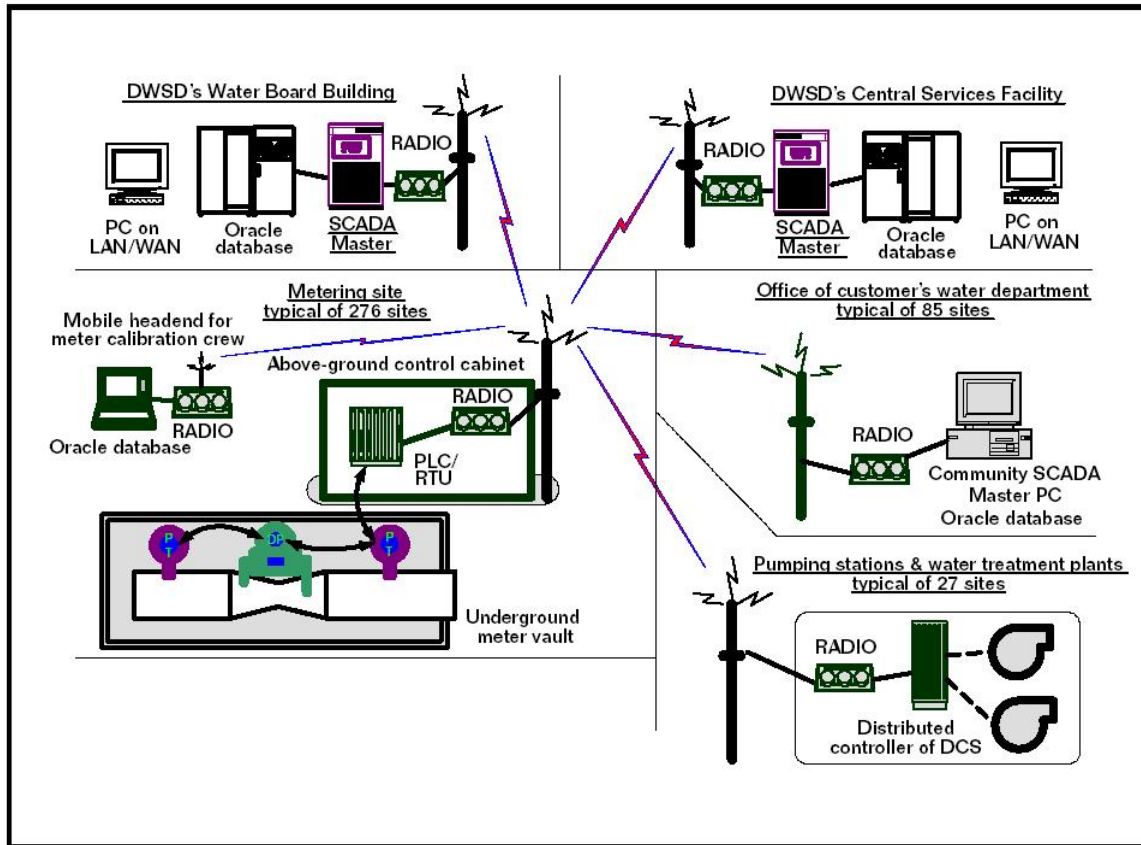

Figure 2. Schematic of DWSD's AMR/SCADA system

The decision to adopt the HART standard for integrating our meters was relatively simple since we already had in-house experience. Perhaps, more importantly, HART was evaluated to be the only stable and reliable technology available at the time which would enable us to integrate a vast array of diverse field devices and technologies including mechanical, venturi, orifice, magnetic and sonic meters into a single digitally networked system.

Other field device technologies such as FOUNDATION™ fieldbus and Profibus-DP were still evolving, costly, and radically different and incompatible with our existing smart instrumentation. Use of these other technologies would have substantially increased the project risk and the total installed costs.

HART technology was an ideal fit for our requirements since it delivered the benefits of an all-digital system at a minimized incremental investment for the modernization project. Most of our existing instrumentation was HART-capable, which enabled us to use the existing wiring. The project easily gained management approval mainly due to our ability to default back to the existing analog-chart-recorder system in case of difficulties.

Maintaining the Look and Feel of Mechanical Meters to Ease Transition

At the start of the pilot project, our technicians and customers indicated a strong preference for mechanical meter-type totalizers at each metering site. To improve their comfort level with the

electronic instruments, we configured the LCD displays of the HART-based smart instruments to indicate the current value of the measured variable, e.g., flow rate and/or totalized flow, which provided an emulation of the odometer-like registers of the mechanical meters. Figure 3 illustrates one such HART-based smart instrument (manufactured by SMAR International) indicating measured flow rate. The LCD alternates displaying the flow rate and totalized flow (not shown).



Figure 3. HART-based smart instrument indicating flow rate (PV measured in m^3/hr)

Unlocking the Power of HART to Reap Big Dividends

Most HART-based smart devices are capable of performing multiple functions in a single instrument. Previously, we required multiple electrical devices for detecting the rate of flow, outputting a proportional signal, integrating the proportional rate signal into a volume, and totalizing the volume.

Thus, by combining functions we were able to eliminate these old devices, as we selected HART-based differential pressure transmitters that are capable of performing on-board, flow totalization and self-monitoring for diagnostics. In addition, the HART data communications protocol provides the values to the PLC/RTUs in binary bit streams that virtually eliminate signal transfer errors.

As a result of HART technology, we were able to distribute the totalization function to a lower, HART-enabled smart device level, instead of the traditional PLC/RTU device. This resulted in reducing the load on the PLC/RTU, as well as eliminating the potential loss of data in case of a power loss. A schematic diagram of an advanced metering system based on HART technology is illustrated in Figure 4.

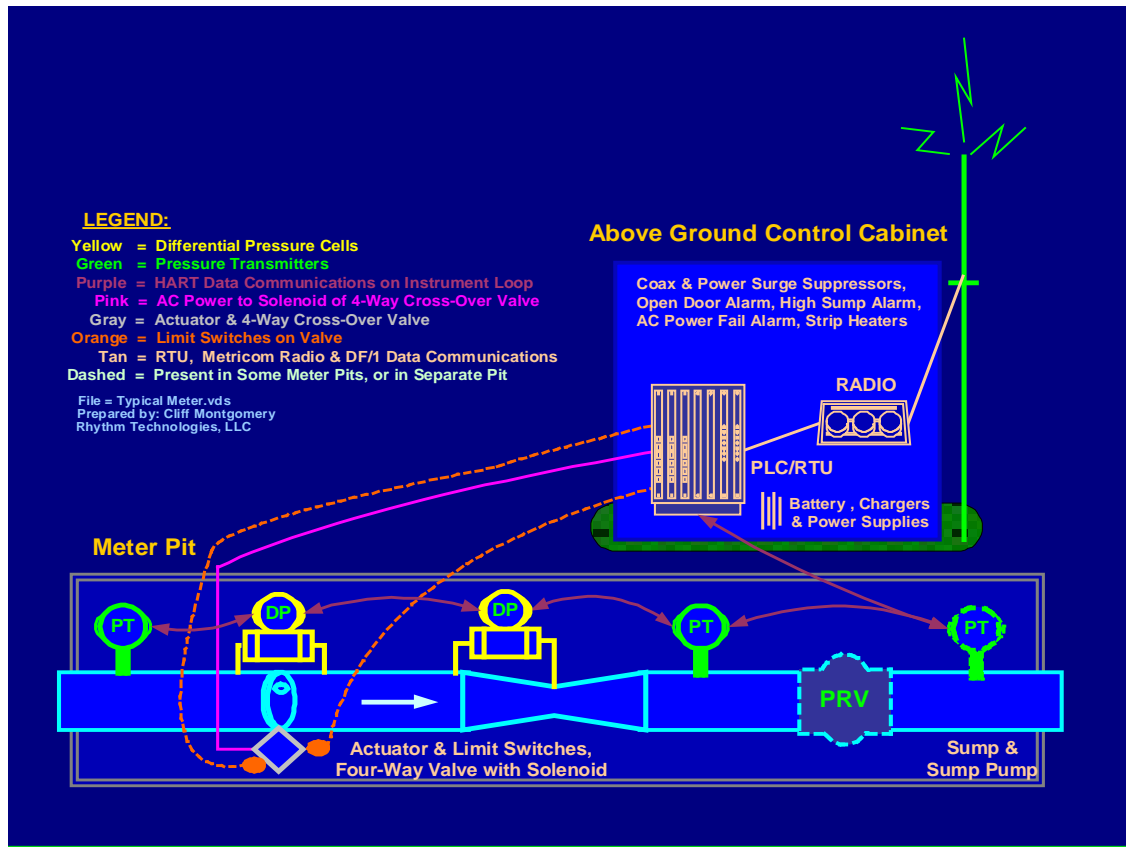

Figure 4. Schematic of a Venturi/Orifice meter based on HART technology

The flow totalization data is actually retained in the memory of each HART-enabled smart instrument even when there is a loss of power. As a matter of fact, our system survived the massive power failure of August 14, 2003 that occurred in the Northeastern part of the United States with little or no loss data. This was an unrehearsed critical test since it occurred during our peak-revenue summer months.

As an additional benefit, by executing the totalization function at the HART device level, we were able to obtain much more accurate totalization data. The HART device integrates totalization data sampled far more frequently than the PLC/RTU. As a result, the totalization values are more accurate.

The sampling frequency of the microprocessor based instrument approaches the Nyquist criteria for integrating the fluctuations of the water flowing through venturis and orifices that can reach to audio frequencies. The best of the communications protocols for instrumentation are substantially slower resulting in random sampling errors that although small relative to instantaneous flow, accumulate in the totalized flow far beyond acceptable limits.

With the need to read instantaneous flow for range switching combined with the necessity of totalizing flow in the instrument, this project would have been far more costly without the HART ability to read multiple functions in a single smart instrument. By shifting the calculations to the smart instruments, we freed the PLC/RTU to perform other tasks, such as device monitoring for all HART devices located at the underground metering facilities, and storing 31 days of metering data collected at 5-minute intervals.

We were also able to maintain greater accuracy of metering data throughout our water-distribution system, largely due to HART's ability to preserve the full accuracy of the measuring element in a digital format. The improved accuracy has directly resulted in increased revenues, since our old mechanical meter based cash registers often erred in favor of our wholesale customers.

The need for having redundant metering systems has been eliminated since the same metering data reported from our HART-based instruments to the RTU, is "carbon copied" every five minutes directly from the on-site RTU to DWSD as well as to our wholesale customers within a few seconds – we provided a SCADA PC to each wholesale customer. This has already contributed to improved customer satisfaction.

Our wholesale customers can access metering data received from their respective meters directly rather than receiving it through our headquarters. This assures our wholesale customers that DWSD is not adjusting or manipulating their metering data.

HART enables the master device such as the PLC/RTU to automatically query each smart instrument to detect the types and brands of HART-based instruments on the network. Instrument data such as their brand type and serial numbers are collected each day for a permanent record of each instrument. HART enables the detection and documentation of instrument changes that invalidate calibration.

Metering data received from failed instruments is not logged or used in any billing computation. Previously, a failed analog instrument sometimes produced bogus signals thereby corrupting the meter readings.

HART-enabled remote monitoring, calibration, and validation of metering systems have contributed to improved safety and greater customer satisfaction. Our technicians can now perform these tasks on any HART-based smart device in the comfort of their office. For example, pause and resume signals can be sent remotely to these instruments for series connected meters for range switching. With improved diagnostics, our technicians can quickly detect and repair failures in our water distribution system.

Complaints about low water pressure have been virtually eliminated since a majority of these complaints have been attributed to faulty regulating valves operated by our wholesale customers. Our system now monitors these valves and reports any problems directly to the customers.

Safety has also been improved since the need to enter the OSHA regulated confined space of the underground metering facilities for troubleshooting purposes has been greatly reduced or eliminated. Previously, there have been fatal accidents in these underground metering facilities.

Metering data obtained from the HART-instrument is communicated and stored in digital form, eliminating paper-based recordings. A digital packet radio network, which functions like a wireless intranet, is used to "carbon copy" all metering data to redundant data historians and to SCADA PCs that DWSD provided to each customer.

The DWSD meter technicians use radio linked laptop computers for configuration and direct entry of calibration data, eliminating paper and copying errors. By analyzing the real-time and historical data collected, we have improved efficiency by revising operating procedures.

HART has served us so well by utilizing all of our existing plant assets. Other fieldbus technologies have matured considerably since 1996, when DWSD began piloting our system. Nevertheless, we would still use HART, even if the project were starting today. Other newer fieldbus technologies would have cost us at least twice as much, since we would have had to discard a majority of our existing instruments.

Looking ahead, DWSD is developing another SCADA system for controlling our treated water transmission system and wastewater collection system, which includes new sewer meters. Since many instruments included in the SCADA system are also HART-capable, we would like to tie them in into our water metering AMR/SCADA system.



2003 HART Plant of the Year

MILWAUKEE SEWERAGE DISTRICT USES HART TO SUPPORT SAFER SEWER SYSTEM

PROJECT OBJECTIVES

- Improve measurement by using temperature compensated devices and perform installation calibration in an explosion-proof area.

SOLUTION

- MMSD installed more than 200 level transmitters with HART-based interfaces in manholes, which are Class 1, Division 1-rated areas. MMSD installed the HART instruments because the level instrumentation in place was not temperature compensated.
- The HART dual functionality (analog plus digital) allows seamless operation of the system while the instrument is being interrogated and updated.

RESULTS

- HART-enabled devices saved money for MMSD and those savings coupled with the technology's flexibility, reliability and field ruggedness are why HART devices are used throughout Milwaukee's sewage-treatment system.
- The installation reduces the time to calibrate the instrument and eliminates the need to enter the manhole

To keep its own process competitive, the Milwaukee Metropolitan Sewerage District (MMSD) installed more than 200 level transmitters with HART-based interfaces in manholes, which are Class 1, Division 1-rated areas. MMSD installed the HART instruments because the level instrumentation in place was not temperature compensated.

HART technology's analog functionality allowed an intrinsically safe barrier and installation calibration in an explosion-proof area. "The collection-system manholes are typically entered once-a-year for calibration checks," explains Eugene Moe, senior instrumentation and control engineer for Earth Tech Inc. in Sheboygan, Wisconsin. Earth Tech was part of a joint venture team hired to manage MMSD's operations.



“The result is an installation that reduces the time to calibrate the instrument and eliminates the need to enter the manhole, unless the unit fails completely.”

This analog functionality plus HART Protocol’s simultaneous digital functionality is important to Moe. “It’s not critical that the signal and calibration be available at the same time,” he explains. “But the dual functionality allows seamless operation of the system while the instrument is being interrogated and updated.”

Moe asserts that using HART-enabled devices saved money for MMSD and adds that those savings coupled with the technology’s flexibility, reliability and field ruggedness are why HART devices are used throughout Milwaukee’s sewage-treatment system.

PERSIAN GULF COMPANY USES HART COMMUNICATION TO IMPROVE WATER CONVERSION PROCESS

PROJECT OBJECTIVES:

- Get better resolution and accuracy from measurement devices
- Save time and labor in calibration and troubleshooting.
- Achieve best functionality of asset management
- Obtain access to all instrument/device data

SOLUTION:

- Install more than 2,000 HART-enabled devices.

RESULTS:

- Saved time and labor in calibration and troubleshooting during pre-commissioning, startup and commissioning.
- Analog signal provided the fastest and best overall scan period
- Digital signal helped to quickly calibrate and troubleshoot devices including control valve positioner feedback
- HART technology's interoperability capability allowed integration of asset management system and devices from different manufacturers
- Remote troubleshooting of device status reduced time needed to check devices in the field
- No disputes because HART is proven to be a very reliable platform

Saline Water Conversion Corporation (SWCC) used HART technology in a major re-instrumentation project as the catalyst for improving asset management. "Despite the size of this mega project, HART technology helped us at the core achieving best resolution and accuracy of the data," says T. Veeresh Prasad, Yokogawa Engineering.

The Saline Water Conversion Corporation (SWCC) used HART technology in a major re-instrumentation project as the catalyst for improving asset management. The company installed more than 2,000 HART-enabled devices in a facility in Jubail, Saudi Arabia, that houses six 60-megawatt power plants and a desalination plant. Water and electricity from the facility service both Jubail and the Saudi capital, Riyadh.

“Despite the size of this mega project, HART Communication helped us at the core,” says T. Veeresh Prasad, Yokogawa Engineering Asia System Integration Center, Singapore. “HART technology achieved best resolution and accuracy of the data, compared to the old devices that were in place for the past 20-plus years.” (The Al-Jubail Phase 1 plant was built on the Persian Gulf in 1982)

Installation of the new HART devices saved the company time and labor in calibration and troubleshooting during pre-commissioning, startup and commissioning. HART technology’s simultaneous analog and digital communications capability provided an additional benefit.

“Analog communications helped because of our fastest turnaround time requirements for achieving best overall scan period,” Prasad says. Digital helped “to quickly calibrate, and to troubleshoot issues, including control valve positioner feedback, etc.”

HART technology’s interoperability capability allowed SWCC to utilize the instrument asset management system as part of turnkey total system integration and the field devices from different manufacturers using HART-compatible I/O cards. “Best functionality of asset management is achieved, even though the host system and the actual field devices aren’t from the same supplier,” Prasad says.

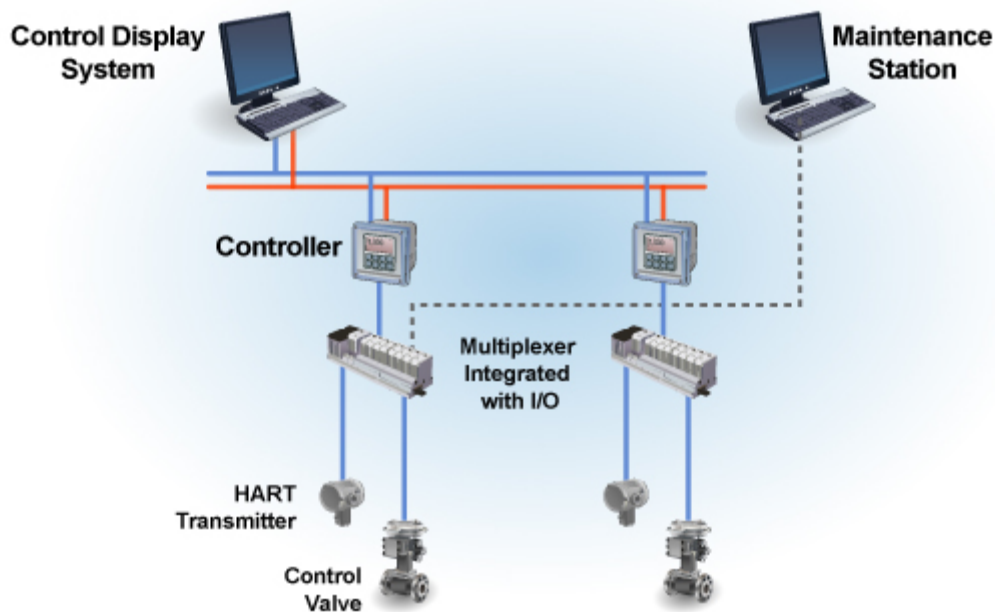

HART-based HMIs provided greater accuracy and were used to calibrate most devices, adds Prasad. And, rather than running to the field to check devices' troubleshooting status, the staff now uses the asset management system to crosscheck that status.

"The result is less disputes—or no disputes," Prasad says. "HART is a very reliable platform for fastest response requirements of control and automation safety-instrumented systems. It competes with all other buses, all the time."

SLUVAD WATER TREATMENT WORKS EMPLOYS HART PROTOCOL'S MULTI-DROP NETWORK CAPABILITY FOR FLEXIBILITY, REDUNDANCY, COST SAVINGS

PROJECT OBJECTIVES

- Automate the water treatment plant for highest possible redundancy
- Renovate filter bed systems while safeguarding the integrity of the plant control system

SOLUTION

- 92 networked HART-enabled instruments installed to control flow, level and pressure
- HART instruments connected using HART Protocol's multi-drop networking capability
- Instruments connect to the DCS using 16-channel HART field modules to multiplex the signals

RESULTS

- Connecting up to four instruments on each multi-drop loop reduced cabling and system I/O requirements nearly 75 percent for significant reduction in hardware and installation costs
- Highly modular design contributed significant engineering and commissioning savings; engineers coded once, copied 28 times

Switching from hydraulic to electric valve actuation, HART Protocol's multi-drop capability proves a time, cost and hardware saver in networking 92 instruments

HART-based instrumentation was used in a major renovation of filter bed systems at the Sluvad Water Treatment Works in South Wales. Water treatment contractor, Purac Ltd., used an innovative design to renovate the plant with HART-based instrumentation and to safeguard the integrity of the plant control system.

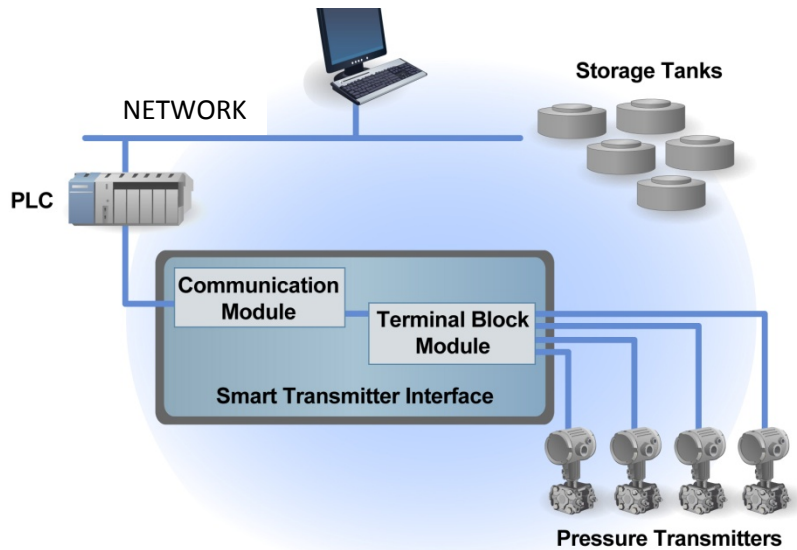

HART Multi-drop Network

According to Purac Senior Engineer Mark Cargill, the project objective was to automate the plant using the most appropriate equipment for giving the highest possible redundancy. After careful evaluation, Purac engineers based their project design on an all-digital HART multi-drop network solution that offered considerable hardware and installation cost savings over traditional 4-20mA and other available options.

“There is such a wide range of HART-compatible products available for flow, level and pressure applications that we found it offered the flexibility and performance we required at the best cost,” Cargill says. “HART was an easy choice because it is a proven, cost-effective technology.”

The project replaced the hydraulically-operated filter bed valves with new electrically actuated valves, and added new instrumentation and a new distributed control system (DCS) to provide full automated control of the entire facility. Because the plant had to stay operational during the refit, a modular design approach with HART-compatible instruments in multi-drop network configurations proved to be the ideal solution for each filter bed.

Twenty-eight rapid gravity filter beds were fitted with a total of 92 networked HART instruments to control flow, level and pressure. All HART instruments are connected using the multi-drop networking capability of the HART Protocol. The instruments are connected to the DCS system using 16-channel HART field modules (HFM) to multiplex the signals.

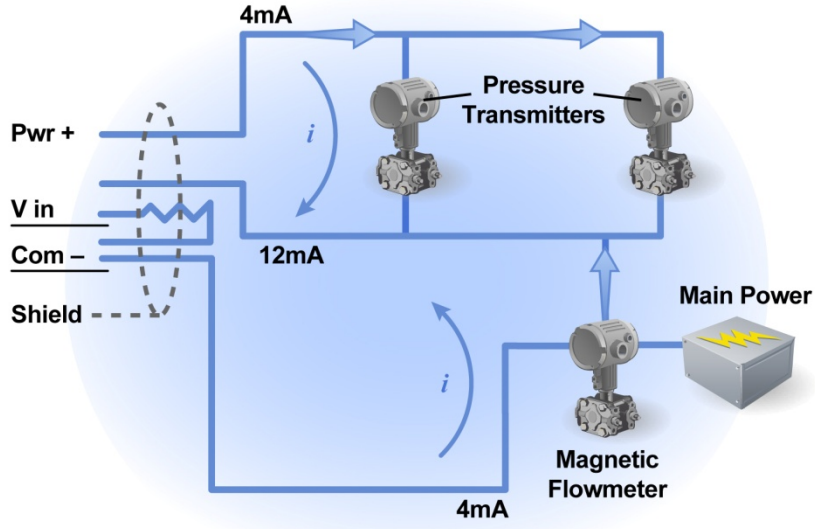

Multi-drop Network with 2 & 4 wire Devices

In a novel architecture, one HFM channel is allocated to each filter bed. “If a problem occurs in any one loop, only one filter is affected,” Cargill says. “The other 27 filter beds remain fully operational, safeguarding the integrity of the plant control system.”

According to Cargill, with up to four instruments on each multi-drop loop, the cabling and system I/O requirements were cut by nearly 75 percent, creating a significant reduction in both hardware and installation costs.

Significant savings in engineering and commissioning were also realized from the highly modular design. System engineers had to develop the design and code only once then repeat it 28 times.

WIRELESSHART APPLICATIONS

INDUSTRY	COMPANY	LOCATION	PAGE #
Steel	Northstar Bluescope Steel	Ohio	173
Energy	Progress Energy	Various	174
Chemical	BASF	Netherlands	176

WIRELESSHART NETWORK HELPS STEEL MILL INCREASE PRODUCTION AND REDUCE COSTS

Replacing a traditional wired network with a *WirelessHART*-based network for control and monitoring has helped Northstar Bluescope Steel improve operations and worker safety in a harsh environment at its mini-mill in Delta, Ohio. By improving furnace control, the mill has increased production by as much as one batch per day (with each batch worth as much as \$200,000), cut maintenance costs (by \$200,000 annually), and improve worker safety.

The self-organizing *WirelessHART* network collects data used to control the temperature of cooling panels and water-cooled burners on the mill's electric arc furnace. This data is critical to safe furnace operation. Overheating cooling panels can lead to major furnace damage, with a blown-out panel costing as much as \$20,000 to repair. Production time is also lost when the furnace must be shut down during maintenance or repairs.

The steel mill replaced a hard-wired monitoring network with hundreds of wiring junctions that suffered frequent measurement failures in the mill's harsh environment, with its high electromagnetic field, flying slag, vibration, moisture, and temperatures as high as 3,000 degrees Fahrenheit.

"Between nine and 12 measurements per week would fail due to high temperatures or physical damage to sensors, cable or conduit," says Kearney. "And when a measurement point fails, the furnace must be shut down. The new wireless solution eliminated almost 100% of the cable and conduit – which reduced maintenance costs by \$200,000 annually."

The Emerson® Smart Wireless network includes 32 Rosemount® *WirelessHART* temperature transmitters; 28 for control and four for monitoring. The transmitters send their data to an Emerson gateway, which interfaces with the mill's transformer-regulation and burner-control system.

"Safety has also been improved," Kearney said. "The furnace's cooling panels are operating consistently at a safe temperature, and there is less maintenance required around the hot furnace shell, where ambient temperatures can be 140 degrees."

ELECTRIC UTILITY USES *WIRELESS*HART COMMUNICATION TO IMPROVE PERFORMANCE EFFICIENCY

Progress Energy, a publicly-owned U.S. electric utility, uses *Wireless*HART communication to improve performance efficiency and output in multiple plant locations. The company keeps plant equipment and systems running smoothly using HART technology for testing, troubleshooting, and verifying performance standards on new and upgraded equipment.

Progress Energy maintains 240 temperature and pressure transmitters and some flow devices at 32 plant locations. Previously, these devices had been hardwired to HART multiplexers to accommodate far-flung cable runs from one site to the next across facilities and even over streets, to conduct tests.

With the introduction of the *Wireless*HART standard and the availability of network *Wireless*HART adapters that conform to the standard, the company sought to replace its aging test equipment and streamline testing with a new wireless system. Dick Fletcher, Progress Energy's Performance Testing Group team manager, notes that the company had a major investment in existing HART smart transmitters. "The logical thing to do was get a common data acquisition system to be shared across the system by performance testing," he says. "A system that could handle a variety of instruments, interface with standard commercial instruments using standard protocols and be easy to configure."

Project objectives

"We had to get the best bang for the buck," says Fletcher, "and that meant that we had to maintain compatibility with our existing investment in HART-enabled transmitters." The goals were to develop a common field data acquisition system; allow equipment sharing across the system and minimize the total company inventory; take advantage of HART's ability to collect data digitally and in multi-drop mode; ease the installation of the test equipment to minimize time and effort, and benefit from a flexible, easily expandable and easily configurable system.

Using recently developed HART-based products, like the MACTek Bullet which supports up to eight HART transmitters in field-proven HART multi-drop mode, meant a wireless gateway could replace failing multiplexers, and far fewer cables would need to be deployed for temporary test transmitter installations.

"The economics of a hybrid wireless-wired HART system became more feasible for us to consider. While we were able to show no connection to the plant's cyber assets, we were impressed with the security of the encrypted HART protocol," says Fletcher, who did have one caveat to using the wireless network adapters. Because *Wireless*HART technology uses the same 2.4-GHz frequency band as Wi-Fi, he was concerned about range limits and the possibility of interference between objects and antennas.

However, in actual use, the HART instruments don't have to be in line-of-sight to establish a network

and, Fletcher notes, “the *Wireless*HART radio links will form in circumstances that Wi-Fi couldn’t hope to achieve, and they just work. Wi-Fi was designed for speed, while *Wireless*HART is designed for data reliability.”

Benefits Realized

The advantages of the new system were apparent, from up-front cost to the long-term reliability of the data acquisition system and, in turn, the reliability of assets across Progress Energy’s 32 plants. Labor savings were evident from the group’s first outing with the new system.

“I estimate that we saved 100-150 man-hours,” says Fletcher. “On a small test, we saved about six man-hours on a setup that took about 10 man-hours to set up using wireless. With an average of 15 tests a year and saving an average 33 hours of labor each, that works out to \$20,000 savings per year.”

Beyond up-front savings, the new system reduces cabling, as the radio links eliminate situations that placed cables at risk of damage. “Along with the streamlined process for data acquisition, we get a better picture in real time of how our test equipment is performing and communicating,” says Fletcher.

While HART is a hybrid analog/digital specification, wireless data transmission is all-digital. This allows HART technology to transcend its heritage as a diagnostic tool and enter the world of digital bus functionality. Fletcher notes the protocol is built for redundancy and reliability.

In wireless multi-drop mode, the analog signal isn’t used; instruments use the 4-20 mA signals for power, but process variables, from tags to diagnostics and process variable measurements, are transmitted digitally. So, in a sense, the technology might open the door for new applications previously thought to be the sole domain of digital fieldbus networks, such as condition monitoring and asset management.

WIRELESSHART AT BASF

Challenging Applications in the Production of High-Quality Catalysts



BASF located in De Meern, the Netherlands



Vacuum dryers for the drying process

In the process industry there is a growing interest in wireless data communication – not for standard connections but for applications where wires cause obstruction. Despite the level of interest, potential users are concerned about data loss, security, or incorrect data transfer. BASF in De Meern has experience with a number of wireless applications.

The plant produces high-quality catalysts (chemical process accelerators) for the process industry, which are used in the chemical, petrochemical, food and pharmaceuticals industry. An example from the food industry is hydrogenation of soya oil to optimize its melting point and storage life for use in margarines or dressings. Other applications include the desulphurization of waste gases and oil, the manufacture of plastics and the conversion of gas into liquid fuels. These processes involve a number of system components for which wireless communication would be a good solution.

Company profile

BASF is one of the world's leading chemical companies. With about 105,000 employees, six verbund sites and close to 385 production sites worldwide they serve customers and partners in almost all countries of the world.

Procedure

When catalysts are being produced the product goes through a number of steps. One of the steps is the drying process, which takes place in a large vacuum dryer. This is a ton in the form of two cones connected at the base, with a diameter of approximately two meters. The product, a powder, can be fed in from the top through the tip of the cone in which a manual valve is mounted. On the other side, the tip of the other cone, there is an access point for taking samples.

The vessel is suspended from two points on each side of the connecting surface between the two cones. The vessel revolves around these points, ensuring that the product is mixed well with a special liquid injected through one of the rotation points.

This liquid forms a coating around the powder grains. The product must then be thoroughly vacuum-dried. The final product is tipped out of the vessel via the same valve.

Samples must be taken regularly during the process to assess how dry the product is. For this purpose the rotating drum is stopped and the operator takes a sample through the special access valve. The sample is then analyzed in the lab. This operation takes between 30 to 45 minutes. Sometimes as many as three samples are taken. When the product is sufficiently dry, the process can be stopped and the product tipped out. The total drying process takes approximately eight hours. For certain types of product it can take 10 to 12 hours.

“We went in search of alternatives so that we could dispense with the time-consuming sampling process and free-up the operators. On the Endress+Hauser stand at a trade fair, we saw a demonstration of a wireless system for measuring temperature. The system used standard transmitters and a module-with-antenna was used to transmit the data signal to a host by means of *WirelessHART*. For us, this was obviously an excellent solution.” - *Ferry Stofberg and Ramon Kranendonk / BASF*

Scope of supply

- Quick scan, system integration and engineering
- HART field devices
- *WirelessHART* Gateway and Adapter
- FieldCare Plant Asset Management
- Commissioning and startup
- Training and instruction

System overview

After the technical solution had been delivered by Endress+Hauser, the BASF engineers looked for additional possibilities. The temperature course is the primary variable for determining the moisture content of the product. In addition, the pressure in the drum is of interest. Therefore two transmitters were fitted, one for pressure and one for temperature. The product in the drum is fairly aggressive, which means special materials were required for the thermowell and chemical seal.

Another criterion was the straightforward integration in the existing system. Control is via Siemens PLCs and PROFIBUS.

FieldCare software is used for maintenance. The gateway has a 24V feed and two outputs, Modbus and Ethernet. The Modbus signal was converted to PROFIBUS DP for communication with a Siemens PLC.

Endress+Hauser provided the essential programming. The connection to FieldCare was via Ethernet.

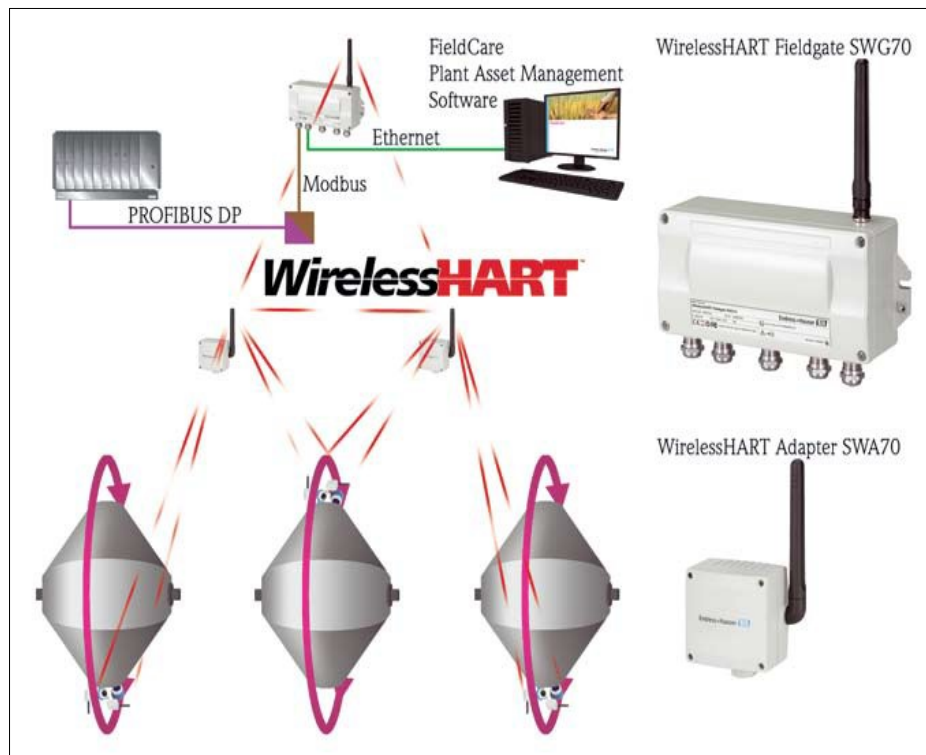

Diagram of the wireless connections

The *WirelessHART* adapters, which also supply power, are mounted directly on the transmitters. Two additional adapters transmit the HART information from the instruments on the continuously rotating drum to the gateway. Experiments are still ongoing, but have already revealed the

P-transmitter uses more energy than the T-transmitter.

Longer intervals (e.g. two minutes) between measurements have already produced an excellent saving. Another idea would be to switch the transmitter on and off when required using *WirelessHART* commands.

The expectation is that, before long, the process can be fully automated, which would result in an impressive time saving and improvement in product quality. At that point, two other drums will also be fitted with the new wireless measuring stations.

“BASF has a number of good applications for wireless communication and, thanks to the support of Endress+Hauser, we are putting them to good use. We won’t be converting other existing parts of the system to wireless, mainly because of the short distances (max. 40 meters). For our factory, wired connections are not a significant cost factor.” - *Ramon Kranendonk / BASF*



Vacuum dryer in vertical position

Customer benefits

- Cost savings on installation and assembly
- Significant reduction of energy and laboratory costs through increased efficiency
- Improved process control and product quality
- Improved availability through condition-based maintenance strategy and centralized device performance monitoring

WHERE TO GET INFORMATION

www.hartcomm.org

- Main Office:** HART Communication Foundation
9390 Research Blvd., Suite I-350
Austin TX 78759 USA
Tel: 512-794-0369
Fax: 512-794-3904
- Europe Office:** HART Communication Foundation - Europe
Contact: Jean-Luc Griessmann
Dornacherstrasse 210
CH-4053 Basel Switzerland
Tel: +41 61 333 22 75
Fax: +41 61 333 22 77
- China Office:** HART Communication Foundation - China
Contact: Wu Minhui
No. 243 Daxue Road, Room 703
Yangpu District, Shanghai 200433
P.R. China
Tel: +86 18916590360
- Japan Office:** HART Communication Foundation - Japan
Contact: Kaoru Sonoda
1-31-10 Shin-machi
Ome, Tokyo 1980024 Japan
Tel: +81-50-5539-9507

APPENDIX A: HART CHECKLIST

HART HOST SYSTEM CAPABILITIES CHECKLIST

Date: _____

Manufacturer:		
Model number/name:		
Revision or version:		
Product application (configurator, DCS, RTU, etc.):		
Function	Commands/Notes	Support Provided
How many HART I/O channels per card?		
Can the system power the devices with an internal power supply?		<input type="checkbox"/> Yes <input type="checkbox"/> No
Which HART revisions are supported?		<input type="checkbox"/> Rev 3 <input type="checkbox"/> Rev 4 <input type="checkbox"/> Rev 5
Is burst mode supported on all channels?		<input type="checkbox"/> Yes <input type="checkbox"/> No
Is multi-drop networking supported on all channels? If yes, how many devices can be placed on a single network?		<input type="checkbox"/> Yes <input type="checkbox"/> No # of devices: _____
How are device-specific functions and features supported?		<input type="checkbox"/> Hard coded <input type="checkbox"/> HART DDL binary files <input type="checkbox"/> HART DDL source files <input type="checkbox"/> Application resource files <input type="checkbox"/> Other: _____ <input type="checkbox"/> Device-specific features are not supported.
Indicate the parameters that are accessed in ANY HART device.		

Manufacturer's identification	0	<input type="checkbox"/> Read <input type="checkbox"/> Display text <input type="checkbox"/> Display code
Function	Commands/Notes	Support Provided
Device identification (device type code)	0	<input type="checkbox"/> Read <input type="checkbox"/> Display text <input type="checkbox"/> Display code
Device identification (unique ID)	0	<input type="checkbox"/> Read <input type="checkbox"/> Display text
Device serial number	0	<input type="checkbox"/> Read <input type="checkbox"/> Display text
Revision levels	0	<input type="checkbox"/> Read <input type="checkbox"/> Display text
TAG	13, 18	<input type="checkbox"/> Read <input type="checkbox"/> Write
DESCRIPTOR	13, 18	<input type="checkbox"/> Read <input type="checkbox"/> Write
MESSAGE	12, 17	<input type="checkbox"/> Read <input type="checkbox"/> Write
DATE	13, 18	<input type="checkbox"/> Read <input type="checkbox"/> Write
Upper-range value	15, 35	<input type="checkbox"/> Read <input type="checkbox"/> Write
Lower-range value	15, 35	<input type="checkbox"/> Read <input type="checkbox"/> Write
Sensor limits	14	<input type="checkbox"/> Read
Alarm selection	15	<input type="checkbox"/> Read
Write-protect status	15	<input type="checkbox"/> Read
Analog reading	1, 2, 3	<input type="checkbox"/> Read
Primary variable	1, 3	<input type="checkbox"/> Read
Secondary variable	3	<input type="checkbox"/> Read
Tertiary variable	3	<input type="checkbox"/> Read
Fourth variable	3	<input type="checkbox"/> Read
Change engineering units	44	<input type="checkbox"/> Read <input type="checkbox"/> Write
Damping value	15, 34	<input type="checkbox"/> Read <input type="checkbox"/> Write
Read device variables How many? (u to 250)	33	<input type="checkbox"/> Read

Materials of construction	Device specific	<input type="checkbox"/> Read <input type="checkbox"/> Write
HART status information (change flag, malfunction, etc.)	Standard status bits	<input type="checkbox"/> Read <input type="checkbox"/> Display text <input type="checkbox"/> Display code
Device-specific status information	48	<input type="checkbox"/> Read <input type="checkbox"/> Display text <input type="checkbox"/> Display code
Use of status bits in control logic?	Std & 48	<input type="checkbox"/> Yes <input type="checkbox"/> No
Use of status bits in alarm handling?	Std & 48	<input type="checkbox"/> Yes <input type="checkbox"/> No
Set point (PID and output devices) Which devices?	Device specific	<input type="checkbox"/> Read <input type="checkbox"/> Write
Support of device-specific commands/ functions: (a) for your own company's field devices (b) for other vendors' field devices		<input type="checkbox"/> Yes <input type="checkbox"/> No <input type="checkbox"/> Yes <input type="checkbox"/> No
Rezero	43	<input type="checkbox"/> Yes <input type="checkbox"/> No
Loop test (fix the analog current at specified value)	40	<input type="checkbox"/> Yes <input type="checkbox"/> No
Support calibration procedures? Which products?		<input type="checkbox"/> Yes <input type="checkbox"/> No
Calibrate the D/A converter	45, 46	<input type="checkbox"/> Yes <input type="checkbox"/> No
Initiate device test	41	<input type="checkbox"/> Yes <input type="checkbox"/> No
Clears configuration flag?	38	<input type="checkbox"/> Yes <input type="checkbox"/> No
Read/Write dynamic variable assignments?	50, 51	<input type="checkbox"/> Yes <input type="checkbox"/> No
Support for devices with multiple analog outputs	6070	<input type="checkbox"/> Yes <input type="checkbox"/> No
Set polling address	6	<input type="checkbox"/> Yes <input type="checkbox"/> No
Text messages provided on command error responses	All	<input type="checkbox"/> Yes <input type="checkbox"/> No
OPC Client		<input type="checkbox"/> Yes <input type="checkbox"/> No

OPC Server		<input type="checkbox"/> Yes <input type="checkbox"/> No
HART Command Pass-through		
<p>Some systems have the ability to act as a conduit or router between a software application running on a separate platform and a HART field device. In effect, this ability gives the end user the functionality provided both by the system and by the application.</p>		
Is pass-through supported?		<input type="checkbox"/> Yes <input type="checkbox"/> No

APPENDIX B: HART FIELD CONTROL

HART Transmitter with PID Control Installation

The HART transmitter with PID control (Fig 21) is wired in series with the field device (valve positioner or other actuator). In some cases, a bypass capacitor may be required across the terminals of the valve positioner to keep the positioner's series impedance below the 100 Ω level required by HART specifications. Communication with the HART transmitter requires the communicating device (handheld terminal or PC) to be connected across a loop impedance of at least 230 Ω . Communication is not possible across the terminals of the valve positioner because of its low impedance (100 Ω). Instead, the communicating device must be connected across the transmitter or the current sense resistor.

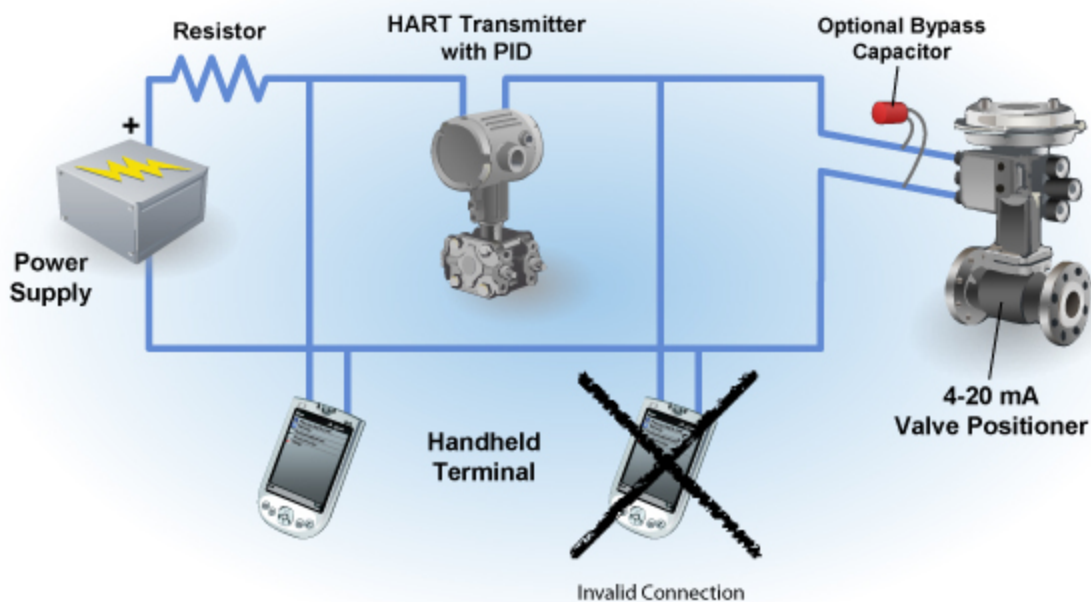

Figure 21 – HART Transmitter with PID Control Wired in Series

It is also possible to use both a smart transmitter and a smart valve positioner in the loop. The control function can be in either device. The HART Protocol allows one low-impedance device on the network, which is typically the current sense resistor. In Figure 22, the smart valve positioner is the low-impedance device, which eliminates the need for a current sense resistor. Communication is possible by connection across the terminal of either the transmitter or the positioner.

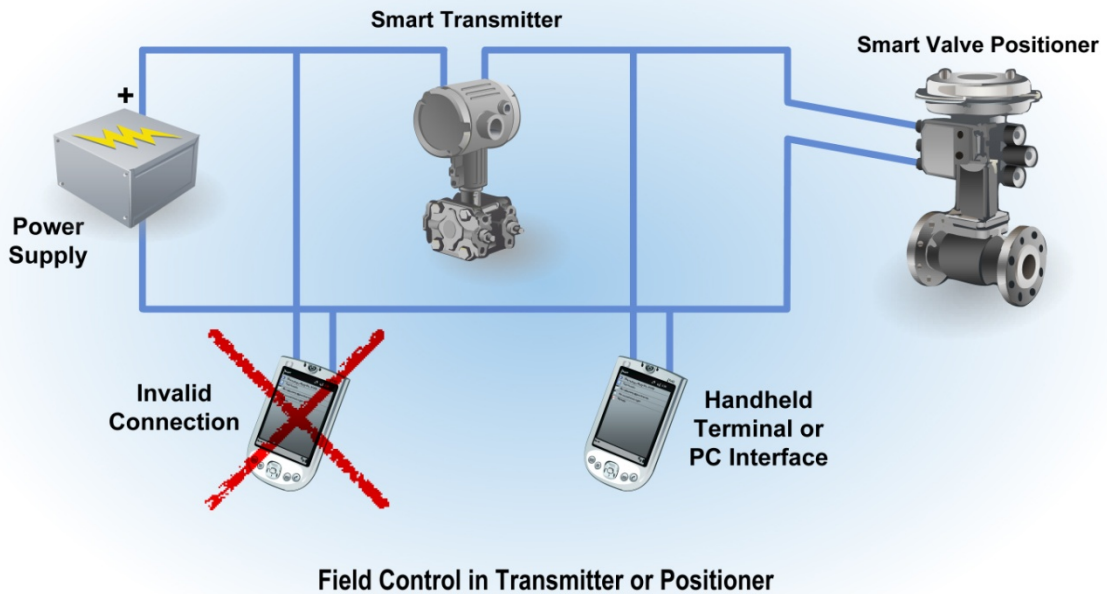

Figure 22 – Field Control in Transmitter or Positioner

APPENDIX C: TECHNICAL INFORMATION

Communication Signals

Type of Communication	Signal
Traditional analog	4–20 mA
Digital	FSK, based on the Bell 202 telephone communication standard
Logical “0” frequency	2,200 Hz
Logical “1” frequency	1,200 Hz

Data Information

Data update rate:

Request/response mode—2-3 updates per second

Optional burst mode—3-4 updates per second

Data byte structure:

1 start bit, 8 data bits, 1 odd parity bit, 1 stop bit

Data integrity:

Two-dimensional error checking

Status information in every reply message

Simple Command Structure

Type of Command	Structure
Universal	Common to all devices
Common practice	Optional; used by many devices
Device specific	For unique product features

Communication Masters

Two communication masters

Variables

Up to 256 variables per device

IEEE 754 floating point format (32 bits) with engineering units

Wiring Topologies

Point-to-point—simultaneous analog and digital

Point-to-point—digital only

Multi-drop network—digital only (up to 15 devices)

Cable Lengths

Maximum twisted-pair length—10,000 ft (3,048 m)

Maximum multiple twisted-pair length—5,000 ft (1,524 m)

Cable length depends on the characteristics of individual products and cables.

GLOSSARY

Bell 202

A U.S. telephone standard that uses 1,200 Hz and 2,200 Hz as 1 and 0, respectively, at 1,200 baud. A full duplex communication standard using a different pair of frequencies for its reverse channel. HART uses Bell 202 signals but is a half-duplex system, so the reverse channel frequencies are not used.

Burst (Broadcast) Mode

A HART communication mode in which a master device instructs a slave device to continuously broadcast a standard HART reply message (e.g., value of a process variable) until the master instructs it to stop bursting

Cable Capacitance per Unit of Length

The capacitance from one conductor to all other conductors (including the shield if present) in the network; measured in feet or meters

Cable Resistance per Unit of Length

The resistance for a single wire; measured in feet or meters

Closed-Loop Control

A system in which no operator intervention is necessary for process control

Communication Rate

The rate at which data are sent from a slave device to a master device; usually expressed in data updates per second

DCS

See Distributed Control System.

Distributed Control System

Instrumentation (input/output devices, control devices, and operator interface devices) that permits transmission of control, measurement, and operating information to and from user-specified locations, connected by a communication link

EDD/DD

See Device Description.

EDDL/DDDL

See Device Description Language.

Electronic Device Description

A program file written in the HART Device Description Language (DDL) that contains an electronic description of all of a device's parameters and functions needed by a host application to communicate with the device

Electronic Device Description Language

A standardized programming language used to write DDs for HART-compatible field devices

Field

The area of a process plant outside the control room where measurements are made, and to and from which communication is provided; a part of a message devoted to a particular function (e.g., the address field or the command field)

Field Device

A device generally not found in the control room; field devices may generate or receive an analog signal in addition to the HART digital communication signal

Frequency Shift Keying

Method of modulating digital information for transmission over paths with poor propagation characteristics; can be transmitted successfully over telephone systems

FSK

See Frequency Shift Keying.

Gateway

A network device that enables other devices on the network to communicate with a second network using a different protocol

HART Command Set

A series of commands that provide uniform and consistent communication for all master and slave devices; includes Universal, Common Practice, and Device-Specific commands

HART Communication Protocol

Highway Addressable Remote Transducer communication protocol; the industry standard protocol for digitally enhanced 4-20 mA communication with smart field devices

HART Handheld Communicator

A handheld master device that uses the HART Communication Protocol and DDL to configure or communicate with any HART device

HART Loop

A communication network in which the master and slave devices are HART compatible

Host Application

A software program used by the control center to translate information received from field devices into a format that can be used by the operator

Interoperability

The ability to operate multiple devices in the same system, independent of manufacturer, without loss of functionality

Intrinsic Safety

A certification method for use of electrical equipment in hazardous (e.g., flammable) environments; a type of protection in which a portion of an electrical system contains only intrinsically safe equipment that is incapable of causing ignition in the surrounding environment

Intrinsic Safety Barrier

A network or device designed to limit the amount of energy available to the protected circuit in a hazardous location

IS

See **Intrinsic Safety**.

Master Device

A device in a master-slave system that initiates all transactions and commands (e.g., central controller)

Master-Slave Protocol

Communication system in which all transactions are initiated by a master device and are received and responded to by a slave device

Miscellaneous Series Impedance

The summation of the maximum impedance (500 Hz–10 kHz) of all devices connected in series between two communicating devices; a typical non-intrinsically safe loop will have no miscellaneous series impedance

Modem

Modulator/demodulator used to convert HART signals to RS232 signals

Multi-drop Network

HART communication system that allows more than two devices to be connected together on a single cable; usually refers to a network with more than one slave device

Multimaster

Refers to a communication system that has more than one master device. The HART Protocol is a simple multimaster system allowing two masters; after receiving a message from a slave device, the master waits for a short time before beginning another transmission, which gives the second master time to initiate a message

Multiplexer

A device that connects to several HART loops and allows communication to and from a host application

Multivariable Instrument

A field device that can measure or calculate more than one process parameter (e.g., flow and temperature)

Network

A series of field and control devices connected together through a communication medium

Parallel Device Capacitance

The summation of the capacitance values of all connected devices in a network

Parallel Device Resistance

The parallel combination of the resistance values of all connected devices in the network; typically, there is only one low-impedance device in the network, which dominates the parallel device-resistance value

Pass-through

A feature of some systems that allows HART Protocol send-and-receive messages to be communicated through the system interface

PID

Proportional-integral-derivative

PID Control

Proportional-plus-integral-plus-derivative control; used in processes where the controlled variable is affected by long lag times

Point-to-Point

A HART Protocol communication mode that uses the conventional 4-20 mA signal for analog transmission, while measurement, adjustment, and equipment data are transferred digitally; only two communicating devices are connected together

Polling

A method of sequentially observing each field device on a network to determine if the device is ready to send data

Polling Address

Every HART device has a polling address; address 0 is used for point-to-point networks; addresses 1-15 are used in multi-drop networks

Process Variable

A process parameter that is being measured or controlled (e.g., level, flow, temperature, mass, density, etc.)

Protocol

A set of rules to be used in generating or receiving a message

PV

See Process Variable.

Remote Terminal Unit

A self-contained control unit that is part of a SCADA system

RTU

See Remote Terminal Unit.

SCADA

See Supervisory Control and Data Acquisition.

Slave Device

A device (e.g., transmitter or valve) in a master-slave system that receives commands from a master device; a slave device cannot initiate a transaction

Smart Instrumentation

Microprocessor-based instrumentation that can be programmed, has memory, is capable of performing calculations and self-diagnostics and reporting faults, and can be communicated with from a remote location

Supervisory Control and Data Acquisition

A control system using communications such as phone lines, microwaves, radios, or satellites to link RTUs with a central control system

Zener

Type of shunt-diode barrier that uses a high-quality safety ground connection to bypass excess energy